

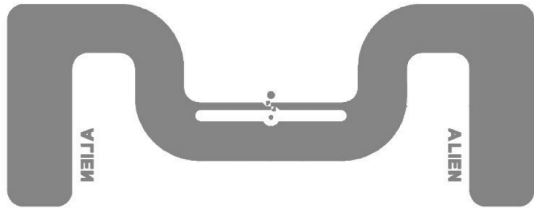

ALN-9770

“BAT” BATTERY INLAY

The Alien Technology® ALN-9770 “Bat” RFID inlay is a specialized tag designed for high-performance when applied to automotive batteries and other challenging metal/plastic/fluid containers.



Applications

- Automotive batteries
- Fluid filled objects
- Tires
- High-dielectric materials
- Plastic containers
- Metal filled objects

FEATURE	DESCRIPTION	BENEFIT
Performance tuned for operating on large fluid/metal filled plastic containers	Highest performance for automotive batteries and other similar challenging containers	Tags plastic objects containing fluid and metal
Next generation Higgs™ 4 features and performance	A mass-market optimized tag with class leading read and write performance. Supports Aliens <i>QuickWrite™</i> and <i>BlastWrite™</i>	Rapid programming of serialized tags and excellent read/write performance

Features:

- › Designed to meet EPCglobal Gen2 (V1.2.0) and ISO/IEC 18000-6C
- › Worldwide operation in the RFID UHF bands (840-960 MHz)
- › 448-Bits of NVRAM Memory
 - 128-EPC Bits
 - 128 User Bits
 - 64 Bit Unique TID
 - 32 Bit Access and 32 bit Kill Passwords
- › Pre-Programmed with a unique, unalterable 64-bit serial number
- › User Memory can be Block Perma-Locked as well as read password protected in 32 Bit Blocks
- › Class leading read and write performance
- › *BlastWrite™* and *QuickWrite™* mass-encoding
- › Dynamic Authentication™ - anti-cloning/anti-counterfeit technology
- › Exceptional operating range, up to 11m with appropriate antenna.
- › Available in high-yield, high capacity dry/wet inlay rolls

Product Overview:

Powered by Alien®’s break-through **Higgs™ 4 UHF RFID IC** and **innovative “Bat” antenna design**, the ALN-9770 delivers industry leading EPC Gen 2 performance and reliability in a specialty tag uniquely focused on effectively tagging automotive batteries.

With its Higgs-4 core, the “Bat” delivers next generation read and write performance, yet is completely **optimized for the highest volume enterprise, retail, and automotive applications.**

An optimized memory footprint includes a 32-bit TID, a **64-bit Unique TID for authentication** and **next generation serialization** applications, a 128-bit EPC memory bank, 128-bits of user memory for distributed data applications, and **password protected read and write** support capabilities to prevent unauthorized viewing and modification of the tag’s data.

ALN-9770 inlays are World Tag compliant, enabling consistent operation across the diverse frequencies of the Americas, Europe, Middle East, Asia, and Africa.

“Just wanted to compliment Alien on this tag. The “BAT” is an awesome tag! We are getting excellent results thus far testing it in a number application but most impressive thus far is using it on “Tires” - “said Conrad Taljaard, Managing Director, from RFIQ (RFID IN OUR WORLD), Centurion, South Africa.

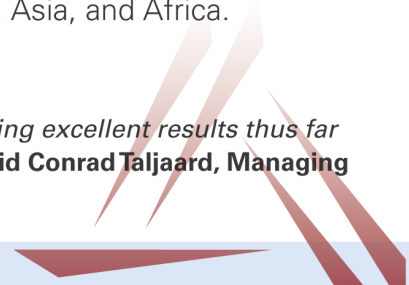



ALN-9770 Bat Inlay

ALN-9770 Antenna Size

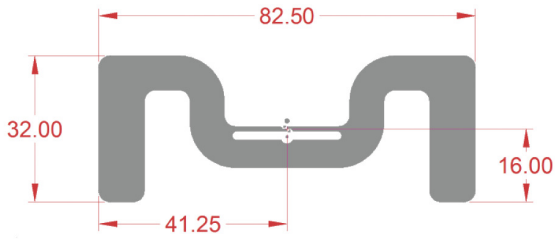

ALN-9770 Inlay Orientation

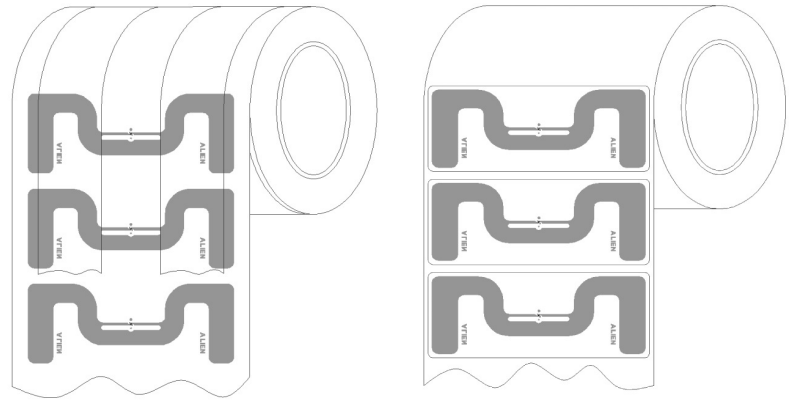

ALN-9770-R
(Dry Unslit Roll)

ALN-9770-WRW
(White Wet Inlay)

Standard Alien Inlay rolls unwind with metal antenna side facing outward, with respect to the core.

ALN-9770 Inlay Specification

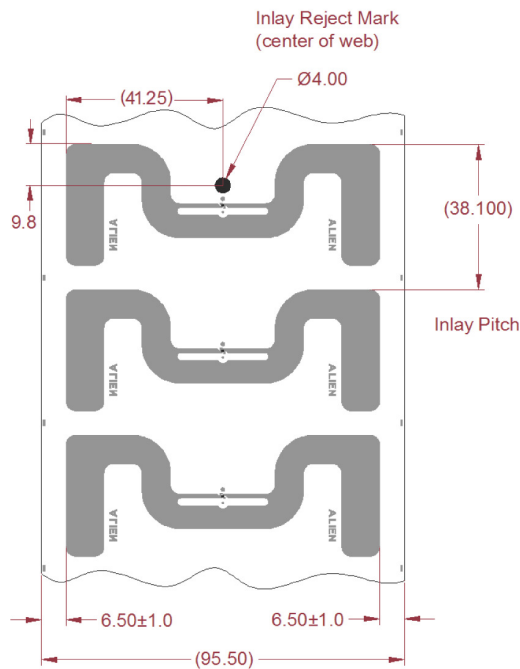

ALN-9770-R
(Dry Unslit Roll)

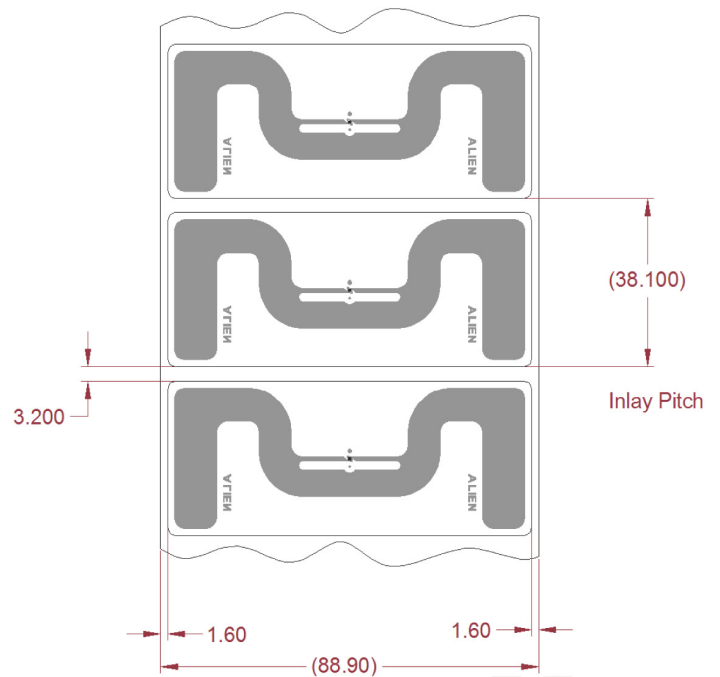

ALN-9770-WRW
(White Wet Inlay)



ALN-9770 Inlay Stackup

DRY INLAY THICKNESS, ±10%	
OVER ANTENNA	0.05 mm
OVER CHIP	0.25 mm

WHITE WET INLAY THICKNESS, ±10%	
OVER ANTENNA	0.16 mm
OVER CHIP	0.36 mm



ALN-9770-R
(Dry Unslit Inlay)



ALN-9770-WRW
(White Wet Inlay)

ALN-9770 Inlay Angular Sensitivity

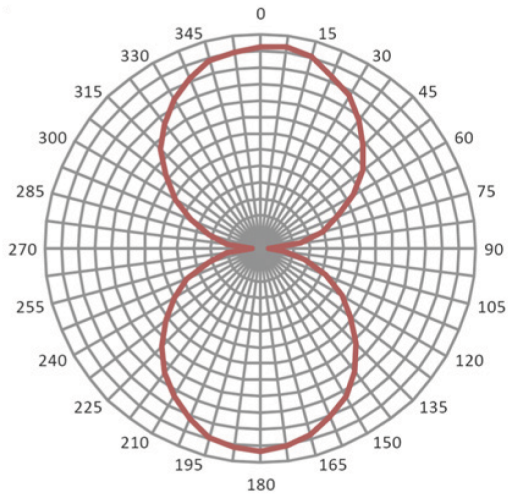

Angular Sensitivity
(Relative Read Range vs. Orientation)

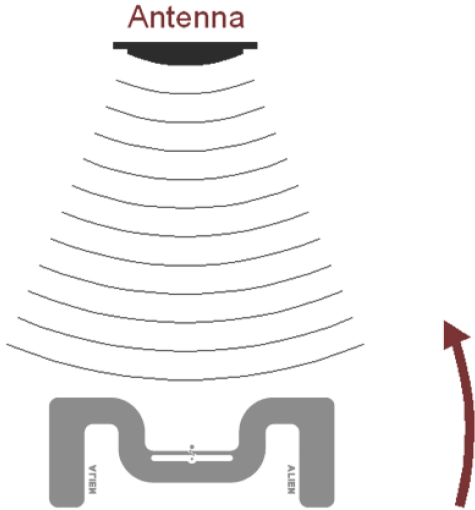

Angular Sensitivity
Inlay is rotated in the x, y, plane about the z axis
(tag shown at 0° with respect to face of antenna)





ALIEN. ALN-9770 Bat Inlay

ALN-9770 Specifications

Dry Inlay

Antenna Width	3.25" [82.5mm]
Antenna Length	1.25" [32.0mm]
Web Width	3.76" [95.5mm]
Web Pitch	1.5" [38.1mm]
Core Width	3.76" [95.5mm]
Core ID	6" [152.4mm]*
Core Material	Fiberboard
Inlays per Roll	7,500 Nominal
Maximum Roll OD	< 12" [304.8mm]
Roll Labeling Data	Roll #, Quantity

Wet Inlay

Inlay Width	3.37" [85.7mm]
Inlay Length	1.37" [34.9mm]
Web Width	3.5" [88.9mm]
Web Pitch	1.5" [38.1mm]
Core Width	3.5" [88.9mm]
Core ID	6" [152.4mm]*
Core Material	Fiberboard
Inlays per Roll	7,500 Nominal
Maximum Roll OD	< 16" [406.4mm]
Roll Labeling Data	Roll #, Quantity
White	TT Printable White Film Only
Overlay Adhesive	General Purpose Permanent
Inlay Adhesive	General Purpose Permanent
Adhesive Application Temperature	> +25°F [-4°C]
Adhesive Service Temperature	-40°F to +200°F [-40°C to +93.3°C]
Release Liner	40# SCK

Environmental

Shelf Life	Dry Inlays: 5 years at +77°F [+25°C] @ 40% RH Wet Inlays: 2 years at +77°F [+25°C] @ 40% RH
Recommended Storage	+77°F [+25°C] @ 40% RH
Storage Limits	-13°F to 122°F [-25°C to +50°C] 20% to 90% RH Non-condensing
Operating Limits	-40°F to +158°F [-40°C to +70°C] 20% to 90% RH Non-condensing
Bend Diameter	> 1.97" [50mm]
Pressure	< 5N/mm ²
Drop Resistance	Per ASTM D5276
Write Cycles	100,000 @ 25°C
RoHs	2002/95/EC, 2005/618/EC, 2011/65/EU Compliant
REACH	1907/2006/EC Compliant (SVHC and ECHA)

RFID

Protocols Supported	ISO/IEC 18000-6C EPCglobal Class 1 Gen 2
Integrated Circuit	Alien Higgs-4
Operating Frequency	840–960 MHz
EPC Size	128 Bits
User Memory	128 Bits
TID	32 Bits
Unique TID	64 Bits
Access Password	32 Bits
Kill Password	32 Bits

* Shipped with 6" to 3" plastic core adapter
July 5, 2016

Copyright© 2016 Alien Technology LLC. All rights reserved.

Alien, Alien Technology, the Alien Technology logo, Spider, Higgs, Dynamic Authentication, QuickWrite, BlockWrite, Squiggle, and the Squiggle logo are trademarks or registered trademarks of Alien Technology Corporation in the U.S. and other countries.

HANDLING PRECAUTIONS Observe standard handling practices to minimize ESD.

DISCLAIMER Application recommendations are guidelines only - actual results may vary and should be confirmed. This is a general purpose product not designed or intended for any specific application.

This product is covered by one or more of the following U.S. patents: 7967204, 7931063, 7868766, 7737825, 7716208, 7716160, 7688206, 7659822, 7619531, 7615479, 7598867, 7580378, 7576656, 7562083, 7561221, 7559486, 7559131, 7554451, 7551141, 7542301, 7542008, 7531218, 7525055, 7506610, 7489248, 7453705, 7425467, 7417506, 7411503, 7385284, 7377445, 7364084, 7353598, 7342490, 7324061, 7321159, 7301458, 7295114, 7288432, 7265675, 7262686, 7260882, 7253735, 7244326, 7218527, 7214569, 7199527, 7193508, 7173528, 7172910, 7172789, 7141176, 7113250, 7101502, 7080444, 7070851, 7068224, 7046328, 6998644, 6988667, 6985361, 6980184, 6970219, 6952157, 6942155, 6933848, 6927085, 6816380, 6780696, 6731353, 6693384, 6683663, 6665044, 6657289, 6623579, 6606247, 6606079, 6590346, 6586338, 6560744, 6555408, 6527964, 6479395, 6468638, 6420266, 6316278, 6291896, 6281038. Other patents pending.

This product is licensed under patents of Round Rock Research, LLC, for use solely with UHF RFID Readers (such as Alien reader products) that are licensed under an agreement with Round Rock Research, LLC.



1.888.238.1155 • Inside USA
1.205.383.2244 • Outside USA

info@atlasRFIDstore.com • www.atlasRFIDstore.com