



Captuvo™ SL22/42

Enterprise Sled for Apple® iPod touch® 5/6 and iPhone® 5

Quick Start Guide

Aller à www.honeywellaidc.com pour le français.

Vai a www.honeywellaidc.com per l'italiano.

Gehe zu www.honeywellaidc.com für Deutsch.

Ir a www.honeywellaidc.com para español.

Перейти на русскоязычный сайт www.honeywellaidc.com.

Pro češtinu jdi na www.honeywellaidc.com.

Pre slovenčinu choď na www.honeywellaidc.com.

Idź na stronę : www.honeywellaidc.com po quick start w języku polskim.

Türkçe için lütfen www.honeywellaidc.com sayfasını ziyaret ediniz.

Para Português, acesse www.honeywellaidc.com.br.

如要到中国 www.honeywellaidc.com (简体)。

查看繁体版请登陆 www.honeywellaidc.com。



CAPTUVOSL22-42-QS Rev C
09/15

Getting Started

Scan this bar code with your smartphone or visit www.honeywellaidc.com/captuvoinstructions for a Getting Started video.



The Captuvo SL22 Enterprise Sled (Agency Model: SL-ES-C) used with the Apple® iPod touch® 5/6 mobile digital device and the Captuvo SL42 (Agency Model: SL-ES-C) used with the Apple iPhone® 5 include an optional integrated imager for scanning all types of bar codes. An optional magnetic stripe reader (MSR) for reading cards with magnetic stripes is also available for non-healthcare sleds.

Note: An imager is standard with the healthcare devices.

*Note: Honeywell is not an authorized Apple repair center. Please return **only** your sled to us for repair. Honeywell is not liable for any non-Honeywell product shipped to our repair center.*

Note: Refer to your Apple iPod touch and iPhone documentation for important product and safety information.

User Documentation

To download the sled documentation, visit www.honeywellaidc.com.

For more information about the sleds, visit www.honeywellaidc.com/honeywellios/captuvoenterprisesleds.html.

Note: Due to the availability of different models, your sled may look slightly different from the illustrations included in this document.

Front View

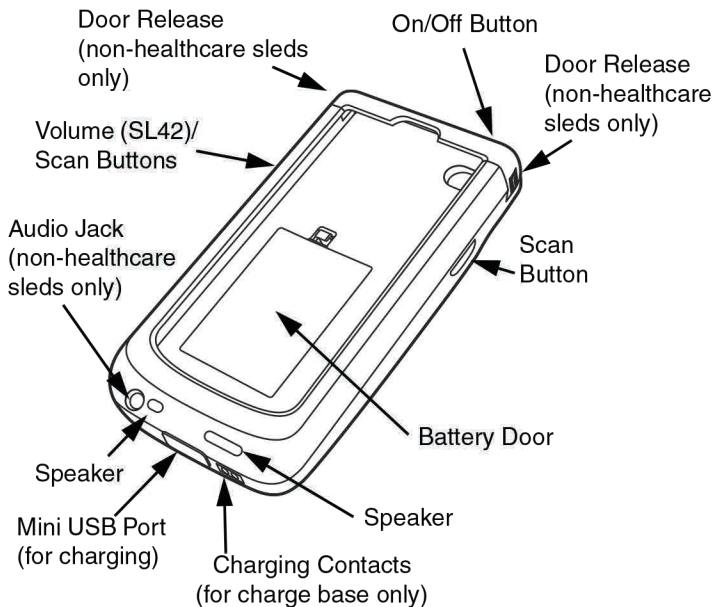

Back View – Non-Healthcare Sled

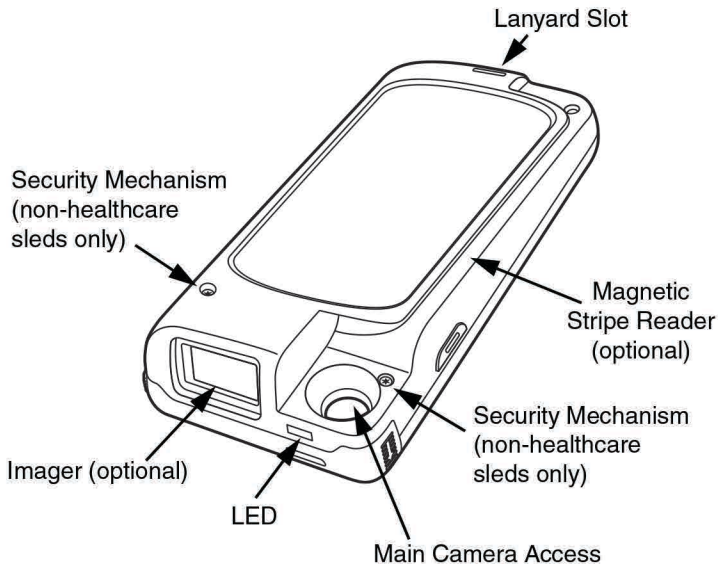

Back View – Healthcare Sled

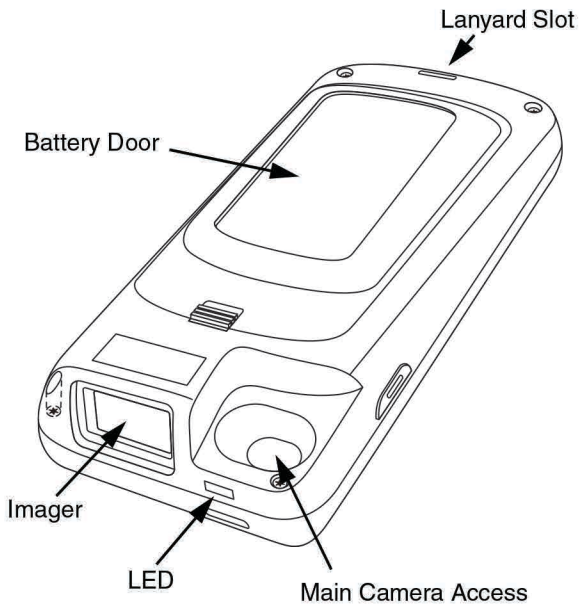

Inserting the Battery



Ensure all components are dry prior to mating sleds/batteries with peripheral devices. Mating wet components may cause damage not covered by the warranty.



We recommend use of Honeywell Li-Ion battery packs. Use of any non-Honeywell battery may result in damage not covered by the warranty.



There is a danger of explosion if the batteries are incorrectly replaced. Replace the batteries with only the same or equivalent type recommended by the manufacturer. Dispose of used batteries according to the recycle program for batteries as directed by the governing agency for the country where the batteries are to be discarded.

Non-Healthcare Sled Battery (1150 mAh)

Battery Door

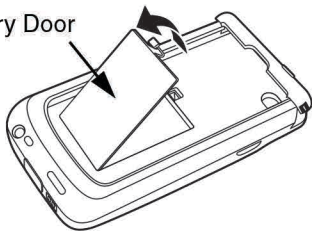

Battery

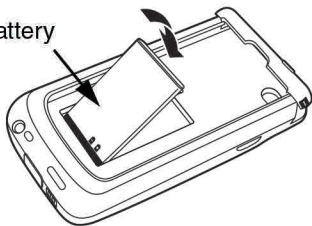

Healthcare Sled Battery (3340 mAh)

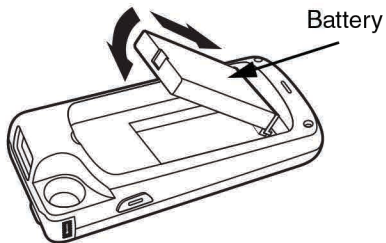
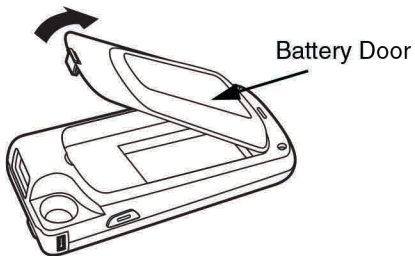

Installing the Apple Device into a Non-Healthcare Sled

1. For non-healthcare sleds, open the door by pushing the top **toward the front of the sled**.
2. Slide your device into the sled.

Note: Be careful that the connectors are not accidentally damaged.

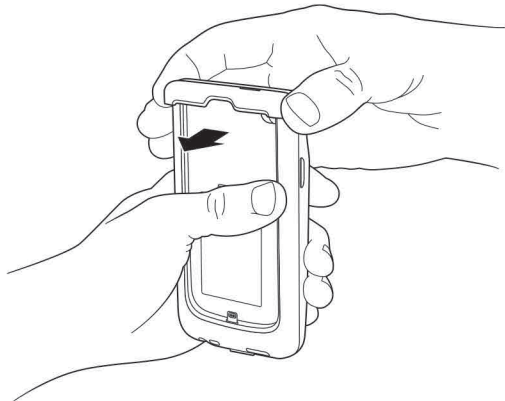

Installing the Apple Device into a Healthcare Sled

1. For healthcare sleds, remove the four TORX (T6) screws on the back of the unit.

Note: If you are using an Apple iPhone 5c, carefully remove the adapter that is pre-installed in the sled. If you are using an Apple iPhone 5/5s, leave the adapter installed.

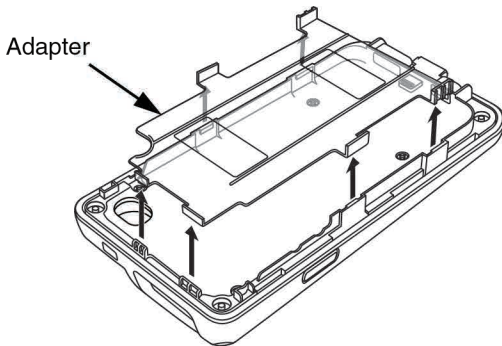

2. Place the Apple device into the sled and press the top and bottom housings together and tighten the four screws. Be certain not to over tighten the screws.

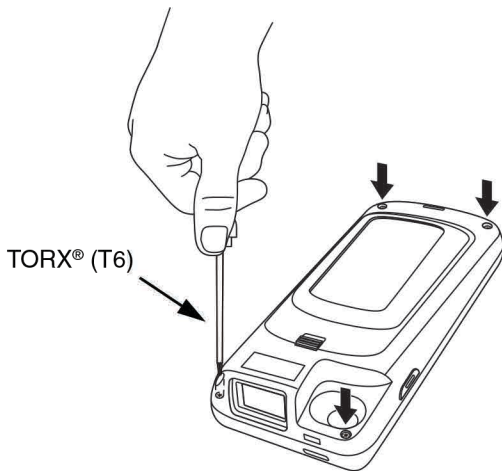

Non-Healthcare Sled Security Mechanism

Note: To reduce the risk of the Apple device being removed or disengaging from the non-healthcare sled, we recommend that you lock both of the security mechanisms.

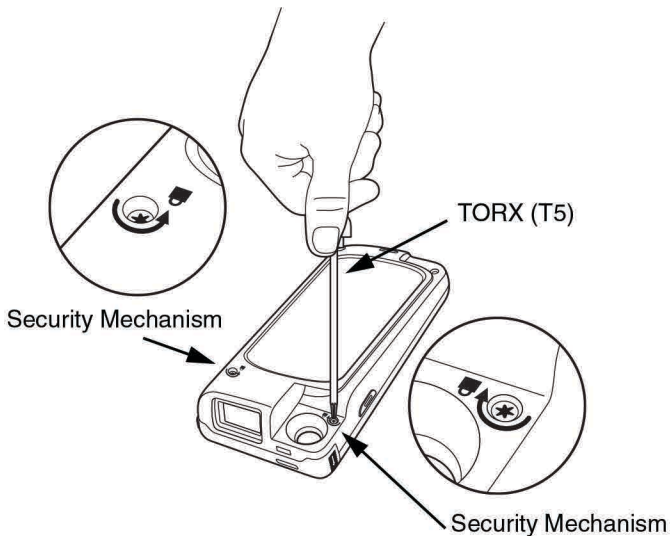

Charging Using Wall Adapter

Note: If you use the wall adapter, both the sled and the iOS device charge.

Note: Use the adapter that came with the iPhone 5 packaging to charge the phone and the sled.

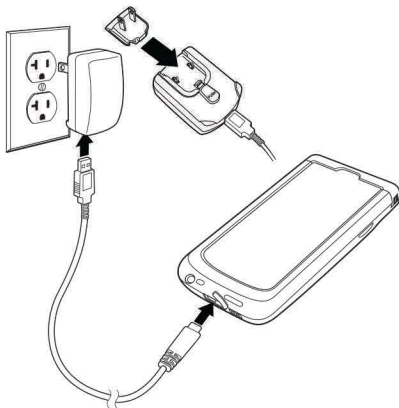

Charging using USB to PC

Note: When the iOS device is in the sled and it is connected to a PC/laptop, only the sled charges. The iOS device cannot be charged or updated via USB.

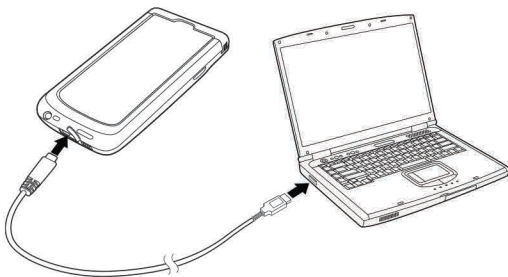

LED Indicators

Color	Indication
Blink Red	Sled's battery power is low (8% and below); needs charging.
Blink Green	Sled's battery is charging.
Solid Green	Sled battery is fully charged.

Demo Apps

To test scanning a bar code, download the Honeywell Price Check application from the Apple App StoreSM. This application is for demonstration purposes only and does not process any data.

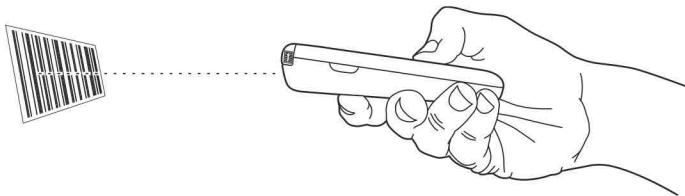

Application Software

The sleds require special application software. Please refer to www.honeywellaidc.com/iosapps for information regarding software.

Reading Magnetic Stripe Cards

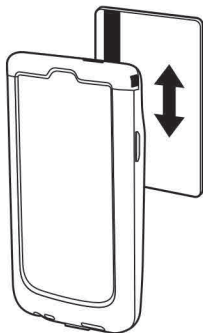

Healthcare Housing Cleaning Directions (Healthcare models only)

Important: The following cleaning solutions have been tested to assure safe cleaning of your sled's disinfectant-ready housing. They are the only solutions approved for use with this sled. Damage caused by the use of cleaners other than those listed below may not be covered by the warranty.

- Gentle dish soap and water
- 409® Glass and Surface Cleaner
- CaviWipes™
- Clorox® Bleach (10%)
- Isopropyl Alcohol Wipes (70%)
- Sani-Cloth® HB
- Sani-Cloth® Plus
- Super Sani-Cloth®
- Virex® 256
- Windex® Blue

Operating Temperature

The maximum operating temperature range for the sleds is 0°C to 35°C (32°F to 95°F).

Technical Assistance

To search our knowledge base for a solution or to log into the Technical Support portal and report a problem, go to www.hsmcontactsupport.com.

Limited Warranty

For warranty information, go to www.honeywellaidc.com and click **Resources > Warranty**.

Patents

For patent information, refer to www.hsmpats.com.

Disclaimer

Honeywell International Inc. (“HII”) reserves the right to make changes in specifications and other information contained in this document without prior notice, and the reader should in all cases consult HII to determine whether any such changes have been made. The information in this publication does not represent a commitment on the part of HII.

HII shall not be liable for technical or editorial errors or omissions contained herein; nor for incidental or consequential damages resulting from the furnishing, performance, or use of this material. HII disclaims all responsibility for the selection and use of software and/or hardware to achieve intended results.

This document contains proprietary information that is protected by copyright. All rights are reserved. No part of this document may be photocopied, reproduced, or translated into another language without the prior written consent of HII.

© 2012-2015 Honeywell International Inc. All rights reserved.

Web Address: www.honeywellaidc.com

Apple and iPod touch are trademarks of Apple Inc., registered in the U.S. and other countries. App Store is a service mark of Apple Inc.

“Made for iPod” and “Made for iPhone” mean that an electronic accessory has been designed to connect specifically to iPod and iPhone respectively, and has been certified by the developer to meet Apple performance standards. Apple is not responsible for the operation of this device or its compliance with safety and regulatory standards. Please note that the use of this accessory with iPod or iPhone may affect wireless performance.