

USER GUIDE: 3166 *BLUETOOTH* RAIN[®] RFID UHF READER



TERMS & CONDITIONS

Copyright © 2024 Technology Solutions (UK) Ltd. All rights reserved.

No part of this publication may be reproduced or used in any form, or by any electrical or mechanical means, without permission in writing from Technology Solutions (UK) Ltd. This includes electronic or mechanical means, such as photocopying, recording, or information storage and retrieval systems. The material in this manual is subject to change without notice.

Technology Solutions (UK) Ltd (TSL®) reserves the right to make changes to any product to improve reliability, function, or design. TSL does not assume any product liability arising out of, or in connection with, the application or use of any product, circuit, or application described herein. No license is granted, either expressly or by implication, estoppel, or otherwise under any patent right or patent, covering or relating to any combination, system, apparatus, machine, material, method, or process in which TSL products might be used. An implied license exists only for equipment, circuits, and subsystems contained in TSL products. TSL and the TSL logo are registered trademarks of TSL. Other product names mentioned in this manual may be trademarks or registered trademarks of their respective companies and are hereby acknowledged.

All software is provided strictly on an “as is” basis. All software, including firmware, furnished to the user is on a licensed basis. TSL grants to the user a non-transferable and non-exclusive license to use each software or firmware program delivered hereunder (licensed program). Except as noted below, such license may not be assigned, sublicensed, or otherwise transferred by the user without prior written consent of TSL. No right to copy a licensed program in whole or in part is granted, except as permitted under copyright law. The user shall not modify, merge, or incorporate any form or portion of a licensed program with other program material, create a derivative work from a licensed program, or use a licensed program in a network without written permission from TSL. The user agrees to maintain TSL's copyright notice on the licensed programs delivered hereunder, and to include the same on any authorized copies it makes, in whole or in part. The user agrees not to decompile, disassemble, decode, or reverse engineer any licensed program delivered to the user or any portion thereof. TSL reserves the right to make changes to any software or product to improve reliability, function, or design. TSL does not assume any product liability arising out of, or in connection with, the application or use of any product, circuit, or application described herein.

iPad, iPad Air, iPad mini, iPad Pro, iPhone, iPod and iPod touch are trademarks of Apple Inc., registered in the U.S. and other countries. iOS is a trademark or registered trademark of Cisco in the U.S. and other countries and is used under license.

Use of the Made for Apple badge means that an accessory has been designed to connect specifically to the Apple product(s) identified in the badge and has been certified by the developer to meet Apple performance standards. Apple is not responsible for the operation of this device or its compliance with safety and regulatory standards.

The *Bluetooth*® word mark and logos are registered trademarks owned by Bluetooth SIG, Inc. and any use of such marks by Technology Solutions (UK) Ltd is under license. Other trademarks and trade names are those of their respective owners.

CONTENT

Introduction.....	4
Parts of the 3166 UHF Reader.....	4
Technical Specifications.....	5
Using the 3166 UHF Reader.....	6
Removing/Installing the Battery.....	6
Charging and USB Connection.....	9
Button Operation.....	10
Reading Transponders.....	11
Status LEDs.....	12
Connections.....	13
USB Connection.....	13
<i>Bluetooth</i> wireless technology connection.....	14
Comparison of <i>Bluetooth</i> Operating Modes.....	15
Changing the <i>Bluetooth</i> Operating Mode.....	16
Setting up a <i>Bluetooth</i> Connection with an Apple Product.....	18
Embedded SD Card.....	23
Summary.....	23
Autorun File (AUTO.TXT).....	23
Log File (LOG.TXT).....	23
Software Development.....	25
Troubleshooting and Maintenance.....	26
Maintenance.....	26
Troubleshooting.....	26
Regulatory information.....	27
Information to the user – FCC.....	27
Canadian Warning Statements.....	28
Battery Information.....	29
Health and Safety Recommendations.....	30
Waste Electrical and Electronic Equipment (WEEE).....	31
Warranty.....	31
About.....	33
About TSL.....	33
Contact.....	33
About HID.....	33

INTRODUCTION

Technology Solutions' 3166 UHF Reader provides Ultra High Frequency (UHF) Radio Frequency Identification (RFID), with optional barcode scanning functionality. The unit can be used stand alone or paired with a *Bluetooth*® wireless technology enabled host device. It can be used with UHF transponders including the EPC Global Class 1 Generation 2 transponders.

PARTS OF THE 3166 UHF READER

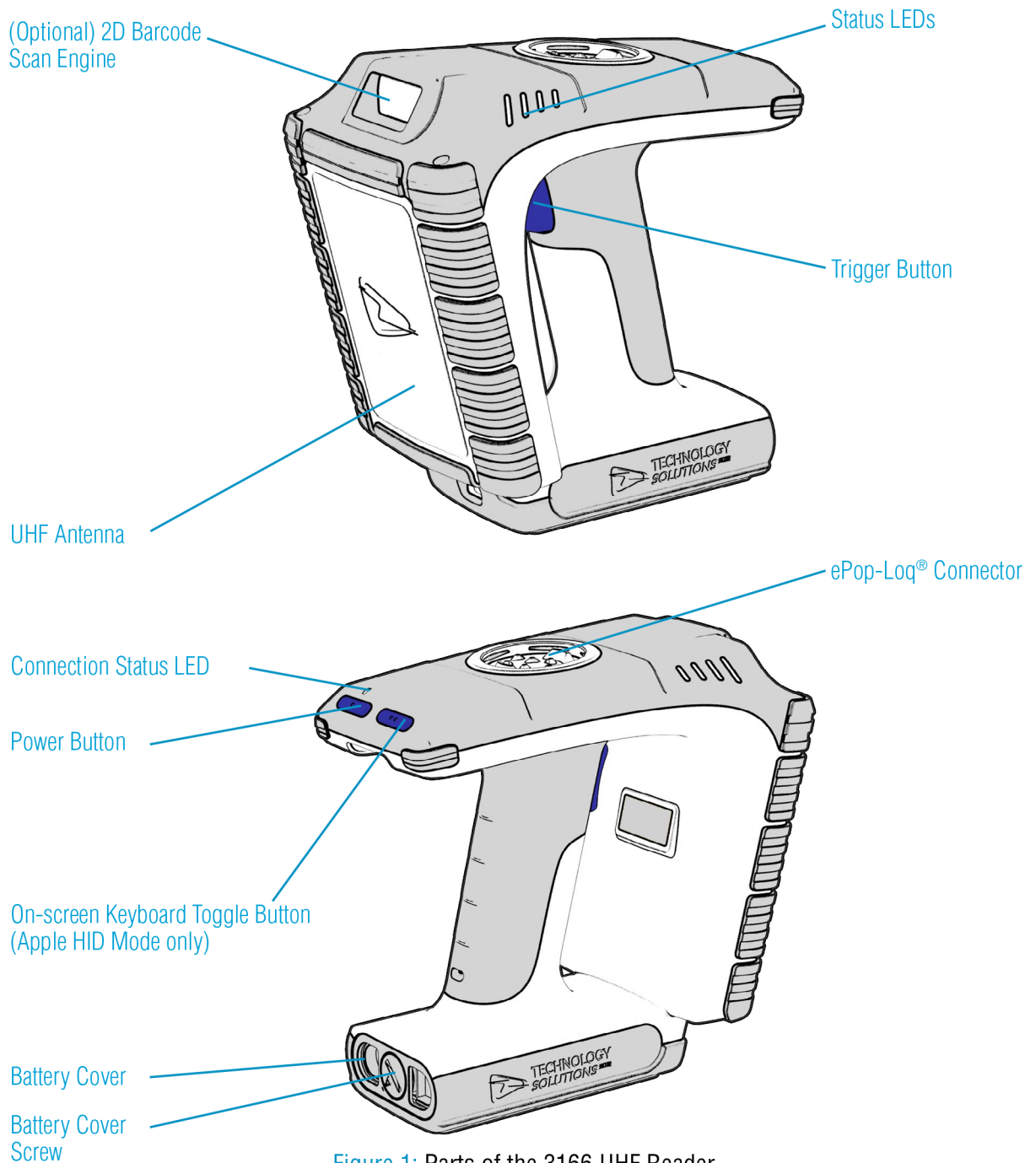

Figure 1: Parts of the 3166 UHF Reader

TECHNICAL SPECIFICATIONS

Physical and Environmental Characteristics

Dimensions:	178 x 105 x 172 mm (LxWxH).
Weight:	865 g / 30.5 oz (including battery).
User input:	Single stage trigger.
User feedback:	Speaker, vibration motor, LEDs.
Power:	Rechargeable Lithium Ion removeable battery pack (10.8V, 3.35Ah, 36.2Wh).
Minimum operating time ¹ :	Light use ² : 33.5 hrs Moderate use ³ : 21.5 hrs Heavy use ⁴ : 12 hrs ⁵
Input Rating:	15.0Vdc, 4.34A.
Enclosure materials:	Polycarbonate and TPU.

Performance Characteristics

RFID engine:	TSL® custom module with embedded Impinj E710.
Communication protocols:	TSL® ASCII 2.0 parameterised command set.
Memory:	Embedded 32GB* storage memory - store up to 500 million date and time stamped EPCs
Compatible Host devices (Bluetooth®):	Any Bluetooth® Host* supporting the Serial Port Profile (SPP) or Human Interface Device (HID) profile (Android, iOS, Linux, Mac, Windows). Comparison of Bluetooth® modes for TSL® UHF Readers.
Compatible Host devices (USB):	Any USB host with USB CDC support (Windows, Linux, Mac, Android).

Environmental

Operating Temp.:	-10°C to 55°C (14°F to 131°F).
Charging Temp.:	5°C to 40°C (41°F to 104°F).
Storage Temp.:	Less than 1 month at -20 to +60°C (-4°F to 140°F). Less than 3 months at -20°C to +45°C (-4°F to 113°F). Less than 1 year at -20°C to +20°C (-4°F to 68°F).
Humidity:	5% to 85% non-condensing.
Drop Spec:	1.8m.
Tumble:	1500 0.5 metre tumbles at room temperature (3,000 cycles).
Environmental Sealing:	IP67.
Electrostatic Discharge (ESD):	± 15kVdc air discharge; ± 8kVdc contact discharge.
MIL-STD 810F:	Meets and exceeds applicable MIL-STD 810F for drop, tumble and sealing.

RFID Performance

Standards supported:	EPC Class 1 Gen2 and EPC Class 1 Gen2V2
Nominal read range ⁷ :	Up to 9 m (29.5 ft).
Nominal write range ⁷ :	Up to 4 m (13.1 ft).
Field:	110-degree forward facing (approx.) measured from front of device.
Antenna:	Circularly Polarised.

Frequency Range:	EU: 865-868MHz, 916-919MHz US: 902-928MHz
Maximum Output Power:	Up to 30 dBm (region dependent) + 4.0 dBIC Antenna.

Barcode Scanning

Optional 2D Barcode Engine:	Optional TSL® custom 2D Barcode Scan Engine module.																								
Sensor Resolution:	1280 x 960 pixels, rolling shutter																								
Field of View:	Horizontal: 44.5°, vertical: 33.5°																								
Focal Distance:	From front of engine: 15.24 cm (6 in.)																								
Aiming LED:	Green LED																								
Illumination:	1 warm white LED																								
Symbologies Supported:	1D: All major codes 2D: PDF417, MicroPDF417, Composite, RSS, TLC-39, Datamatrix, QR code, Micro QR code, Aztec, MaxiCode Postal Codes: US PostNet, US Planet, UK Postal, Australian Postal, Japan Postal, Dutch Postal (KIX).																								
Ranges ⁸ :	<table border="1"> <thead> <tr> <th>Barcode</th> <th>Near</th> <th>Far</th> </tr> </thead> <tbody> <tr> <td>5 mil Code 39</td> <td>6.1 cm</td> <td>24.1 cm</td> </tr> <tr> <td>5 mil Code 128</td> <td>7.1 cm</td> <td>22.9 cm</td> </tr> <tr> <td>6,67 mil PDF 417</td> <td>6.1 cm</td> <td>20.3 cm</td> </tr> <tr> <td>10 mil DataMatrix</td> <td>7.4 cm</td> <td>21.6 cm</td> </tr> <tr> <td>100% UPCA</td> <td>4.6 cm</td> <td>49.5 cm</td> </tr> <tr> <td>15 mil QR</td> <td>3.0 cm</td> <td>29.2 cm</td> </tr> <tr> <td>20 mil QR</td> <td>3.0 cm</td> <td>35.6 cm</td> </tr> </tbody> </table>	Barcode	Near	Far	5 mil Code 39	6.1 cm	24.1 cm	5 mil Code 128	7.1 cm	22.9 cm	6,67 mil PDF 417	6.1 cm	20.3 cm	10 mil DataMatrix	7.4 cm	21.6 cm	100% UPCA	4.6 cm	49.5 cm	15 mil QR	3.0 cm	29.2 cm	20 mil QR	3.0 cm	35.6 cm
Barcode	Near	Far																							
5 mil Code 39	6.1 cm	24.1 cm																							
5 mil Code 128	7.1 cm	22.9 cm																							
6,67 mil PDF 417	6.1 cm	20.3 cm																							
10 mil DataMatrix	7.4 cm	21.6 cm																							
100% UPCA	4.6 cm	49.5 cm																							
15 mil QR	3.0 cm	29.2 cm																							
20 mil QR	3.0 cm	35.6 cm																							

Communication

Bluetooth®:	Bluetooth® v4.2 compliant (v5.1 compatible)
Bluetooth GATT Services:	<ul style="list-style-type: none"> Device Information Service Battery Service HID over GATT Serial over GATT (TSL)
Bluetooth Frequency Range:	2.4 - 2.4835 GHz.
Bluetooth Profiles:	SPP Profile, HID Profile, Apple iAP2, Bluetooth Low Energy.
Bluetooth Range ⁹ :	Up to 100m.
Bluetooth Pairing:	Simple Secure Pairing, NFC OOB Pairing.
Direct USB	Connection via ePop-Loq® cases (separate purchase).

¹ Minimum operating time figures are based on new units that have been stored, charged and operated within the stated Environmental Specifications. Units stored over 3 months must be recharged every 3 months. Number of transponders in the environment affects minimum operating time.

² Light Use: Continuous RFID inventories for 20s of every 120s

³ Moderate Use: Continuous RFID inventories for 10s of every 30s

⁴ Heavy Use: Continuous RFID inventories for 59s of every 60s

⁵ When operating in the "Eco" battery saver mode.

⁶ Compatible Bluetooth® stack required in the Host device

⁷ Tag Read/Write performance is dependent on tag type, items tagged, number of tags in the field and other radio and environmental factors

⁸ Artificial lighting can affect scanning performance

⁹ Open field

USING THE 3166 UHF READER

REMOVING/INSTALLING THE BATTERY

Removing the Battery

To remove the battery, locate the screw on the Battery Cover and rotate it anti-clockwise using a mid-sized coin. The Battery Cover can then be removed. The battery and 'Battery Pull Tab' will now be visible. Use the 'Battery Pull Tab' to slide the battery out.

- 1 Locate 'Battery Cover Screw'

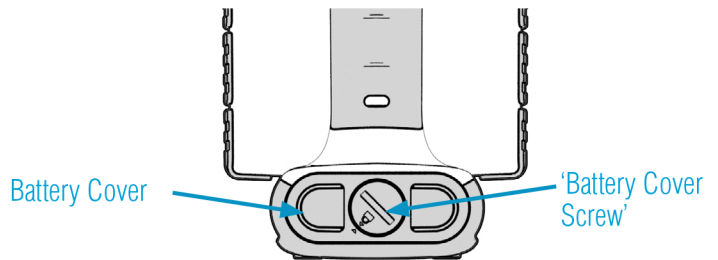
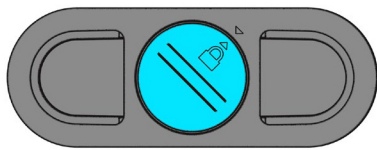

- 2 Rotate 'Battery Cover Screw' anti-clockwise by about two thirds of a turn.

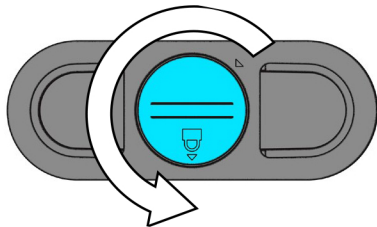

- 3 Remove the 'Battery Cover' using the finger holes and then pull on the 'Battery Pull Tab' to slide the battery out

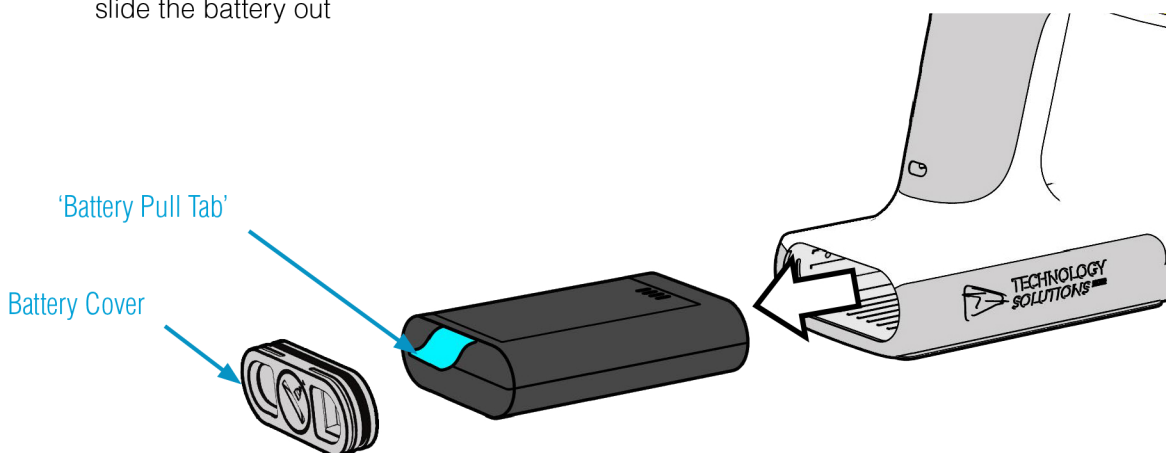

Figure 2: Battery Removal

Installing the Battery

To install the battery, first orientate the battery so that the electrical contacts on the battery line up with the contacts inside the 3166 battery cavity. Slide the battery into the battery cavity, then replace the Battery Cover. Make sure that the 'Battery Pull Tab' does not get stuck between the battery cover and the battery cavity - if this happens then the environmental sealing will be compromised.

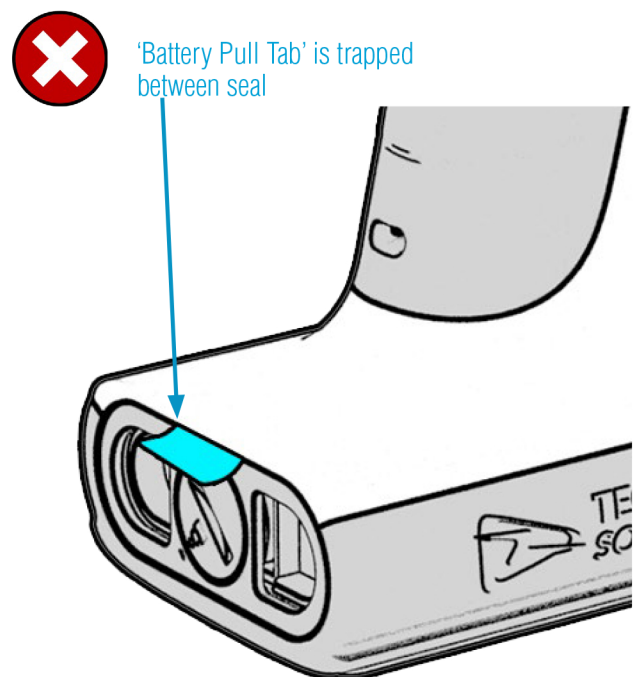
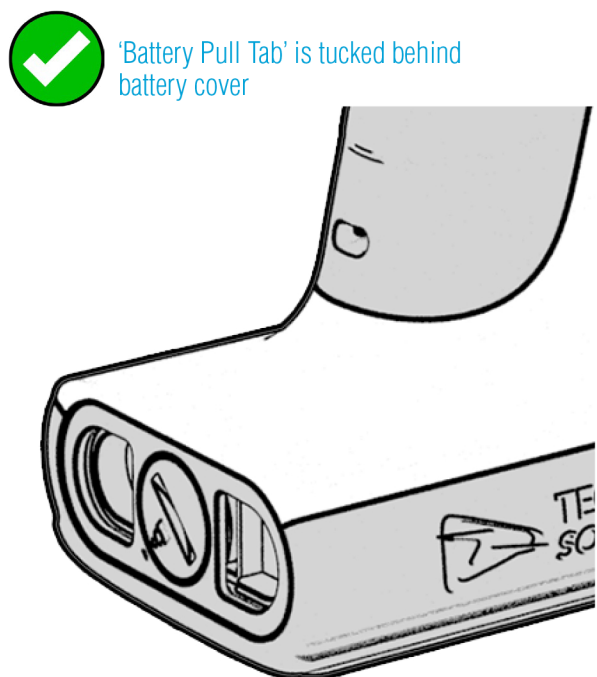
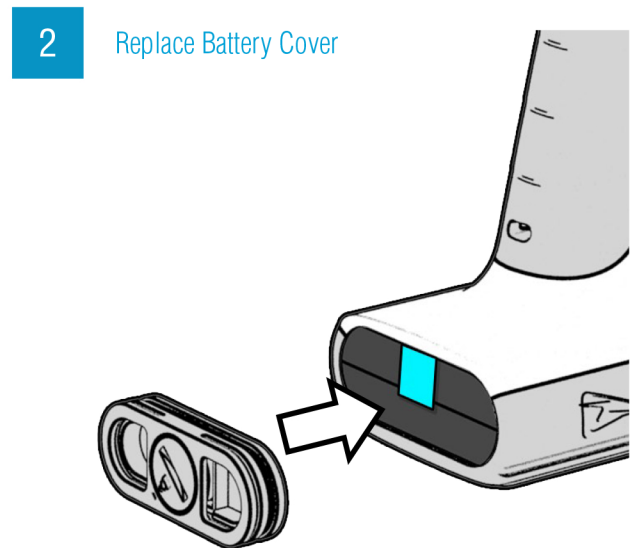
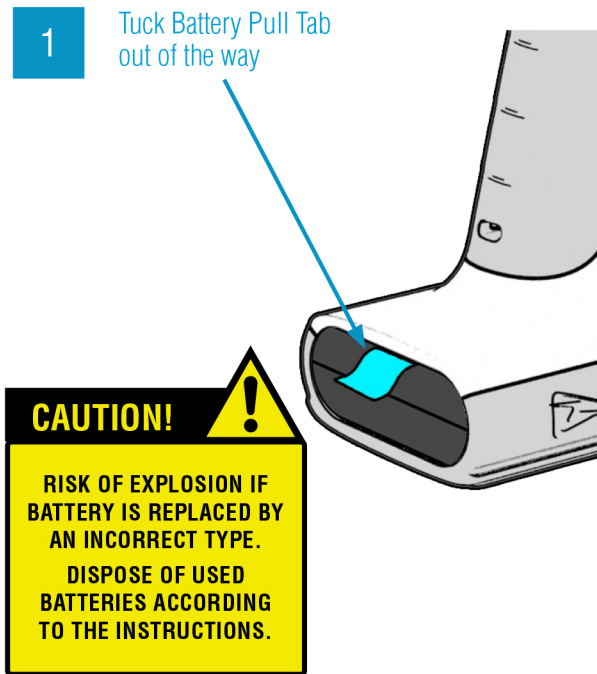
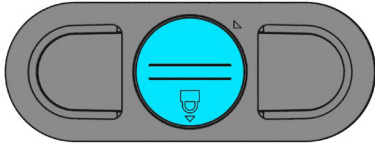

Figure 3: Battery Pull Tab - Correct and Incorrect positioning

Locking the Battery Cover

To lock the battery cover, lightly tighten the 'Battery Cover Screw' in a clockwise direction using a mid-sized coin. Do not over-tighten the screw as this will damage the seal.

- 1 Locate 'Battery Cover Screw'



- 2 Lightly rotate the 'Battery Cover Screw' clockwise until the padlock symbol meets the arrow. Do not over-tighten or you will risk damaging the seal.

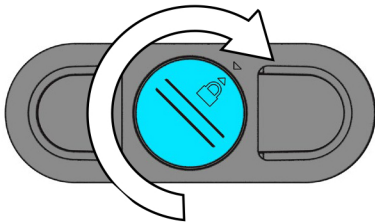

CHARGING AND USB CONNECTION

Setting up the 3166 Docking Station Kit

The 3166 UHF Reader kit uses a dedicated Docking Station for charging and synchronisation. The Docking Station Kit includes the dock, a power supply unit and a Mini USB cable. A separately purchased IEC mains cable is also required. The Mini USB cable and power cable are inserted into the 3166 Docking Station in the orientation shown below. Note that both cables plug into the back of the docking station at a slight upwards angle.

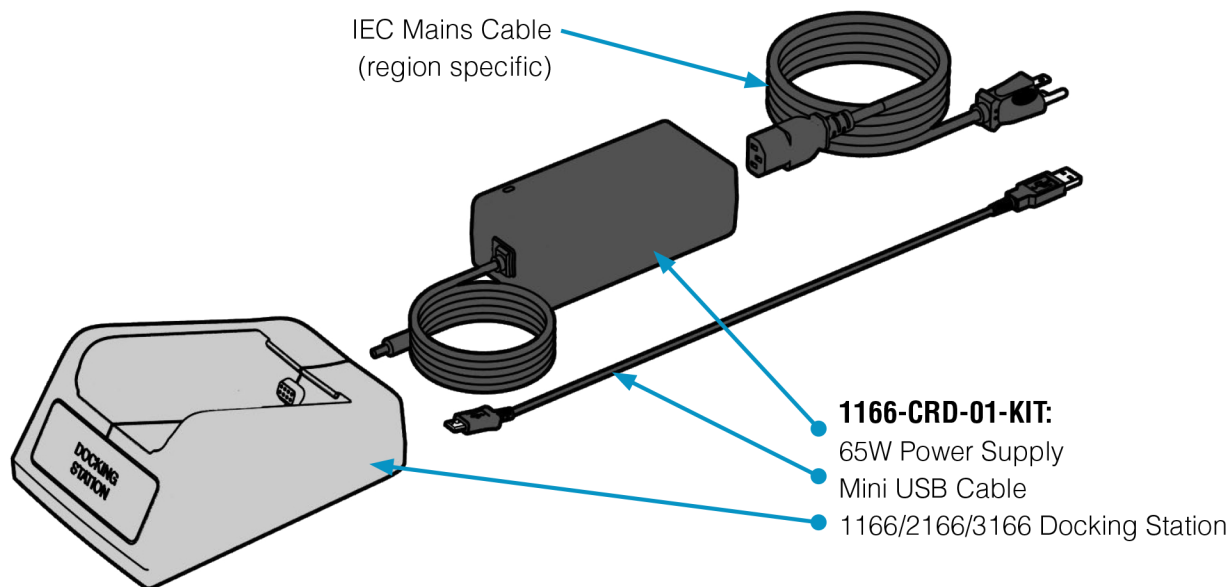

Figure 4: Components required for charging the 3166 UHF Reader

Using the 3166 Docking Station

To dock the 3166 UHF Reader, slide it into the docking station in the direction shown:

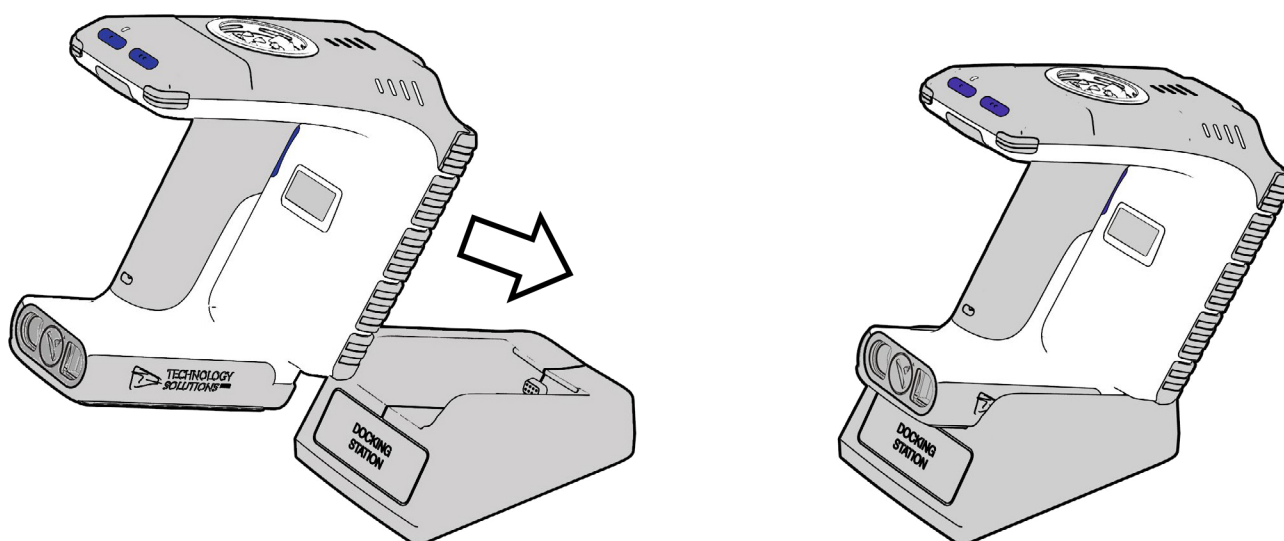

Figure 5: Inserting the 3166 UHF Reader into the 3166 Docking Station

BUTTON OPERATION

The 3166 UHF Reader has a Primary button action and a Secondary button action which can be initiated by different button clicks: By default, the Primary action scans for UHF transponders, whilst the Secondary action initiates the barcode scanner (Barcode scanning is only available with the 2D Imager Antenna variant). Which operation is performed depends on the way in which the button is pressed. The Single and Double press button options are also programmable.

Primary Button Click and Hold

- UHF Transponder Read

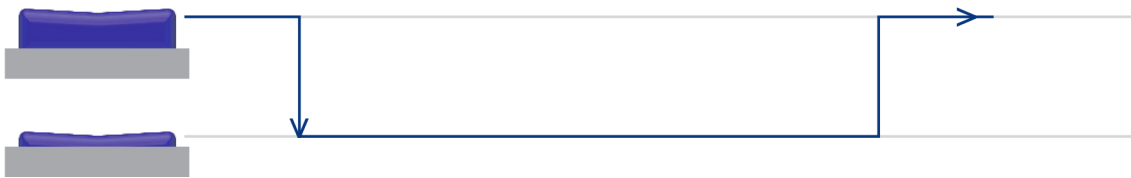

The primary button click is a standard button action:

- To initiate a primary button click press and hold the trigger button.
- To terminate a primary button click release the trigger button.

In the default configuration the 3166 UHF Reader scans for UHF transponders as the primary function. The 3166 UHF Reader will continue to scan for UHF transponders while the button is pressed. It will stop scanning once the button is released (and the current operation completes).

Secondary Button Double Click and Hold

- Barcode Scan (2D Imager Variant only)



The secondary button click is a single click quickly followed by a second press (press-release-press).

- To initiate a secondary button click press then release then press and hold the trigger button.
- To terminate a secondary button click release the trigger button.

In the default configuration the 3166 UHF Reader scans for barcodes as the secondary function. The 3166 UHF Reader will continue to scan for a barcode while the button is pressed. It will stop scanning when any of the following conditions are met:

- A barcode is scanned.
- The button is released.
- The barcode engine times out.

READING TRANSPONDERS

RFID transponders can be read when they are in range of the antenna. The antenna is located on the front of the 3166 UHF Reader. The range at which a transponder can be read depends on the transponder type and size, and the number of transponders in the field.

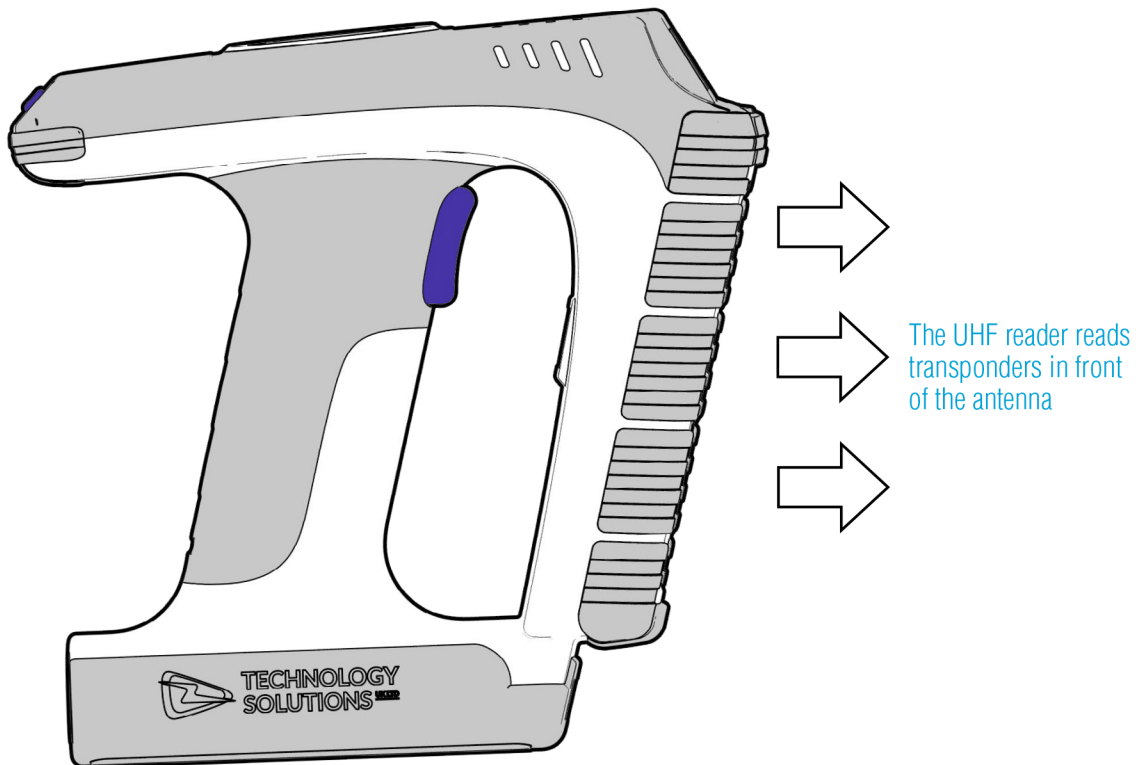

Figure 6: Antenna location and read direction

STATUS LEDs

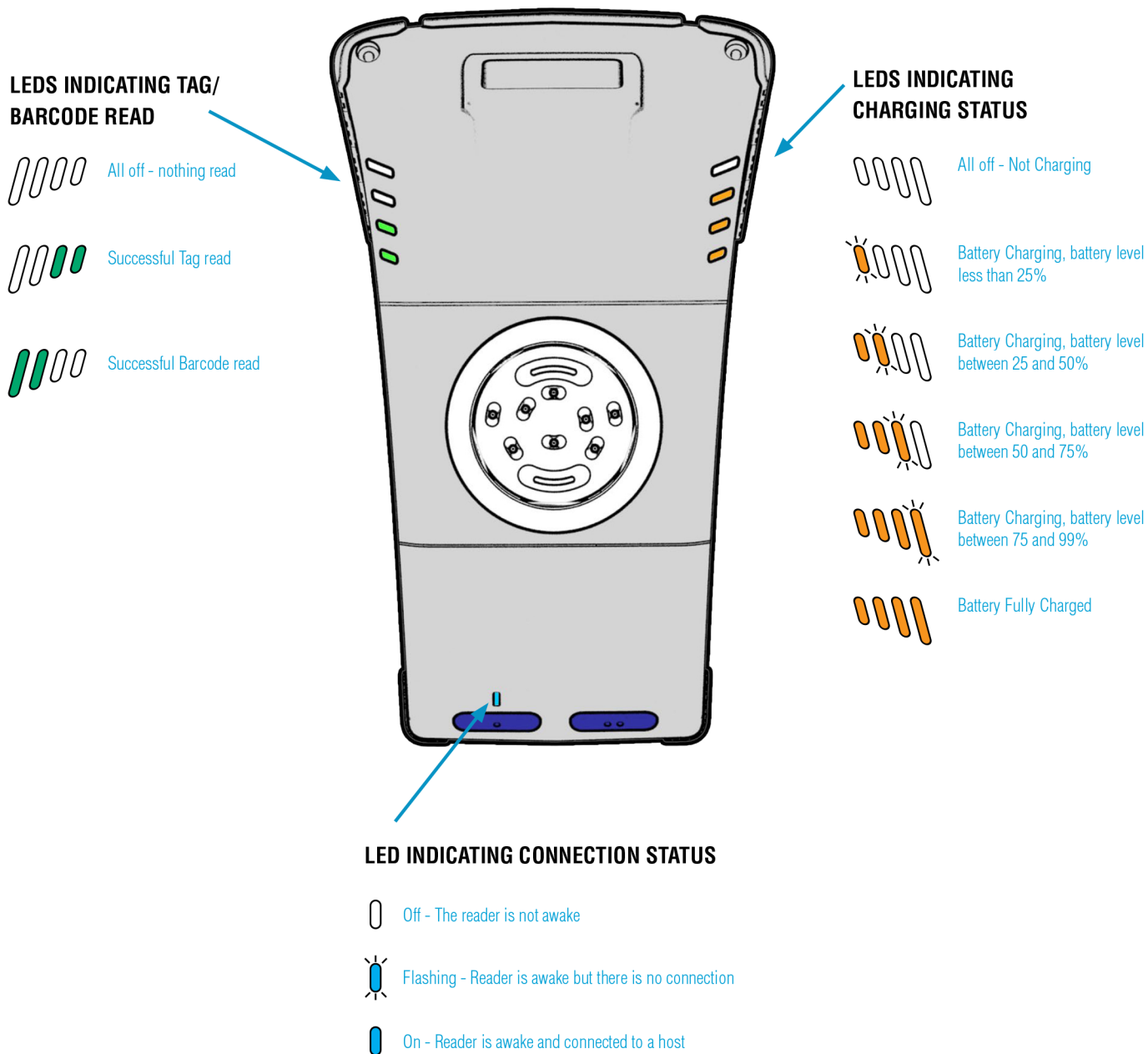

Figure 7: Location of Status LEDs

CONNECTIONS

There are three methods of establishing a data connection to the 3166 Reader:

1. USB (via the dock) Virtual serial port (CDC)
2. USB (via the ePopLoq) Virtual Serial Port (default 115200,8,n,1)
3. *Bluetooth* [Classic] SPP, HID
 [BLE] Serial over GATT (SOG), HID over GATT (HOG)

USB CONNECTION

Overview

The 3166 RAIN RFID UHF Reader has an ePop-Loq® mount which allows the Memor 10, with custom applications, to communicate with the reader via USB instead of *Bluetooth*.

- USB connection will be passed through ePop-Loq to the attached device (via the custom ePop-Loq case).
- USB data connection to the 3166 Reader requires a custom application that supports *TSL ASCII2 Protocol Version 3* over USB.
- If the 3166 Reader is placed into the charge cradle whilst a device is attached to the ePop-Loq, the USB data connection will be disconnected, and both the 3166 Reader and the attached device will charge.

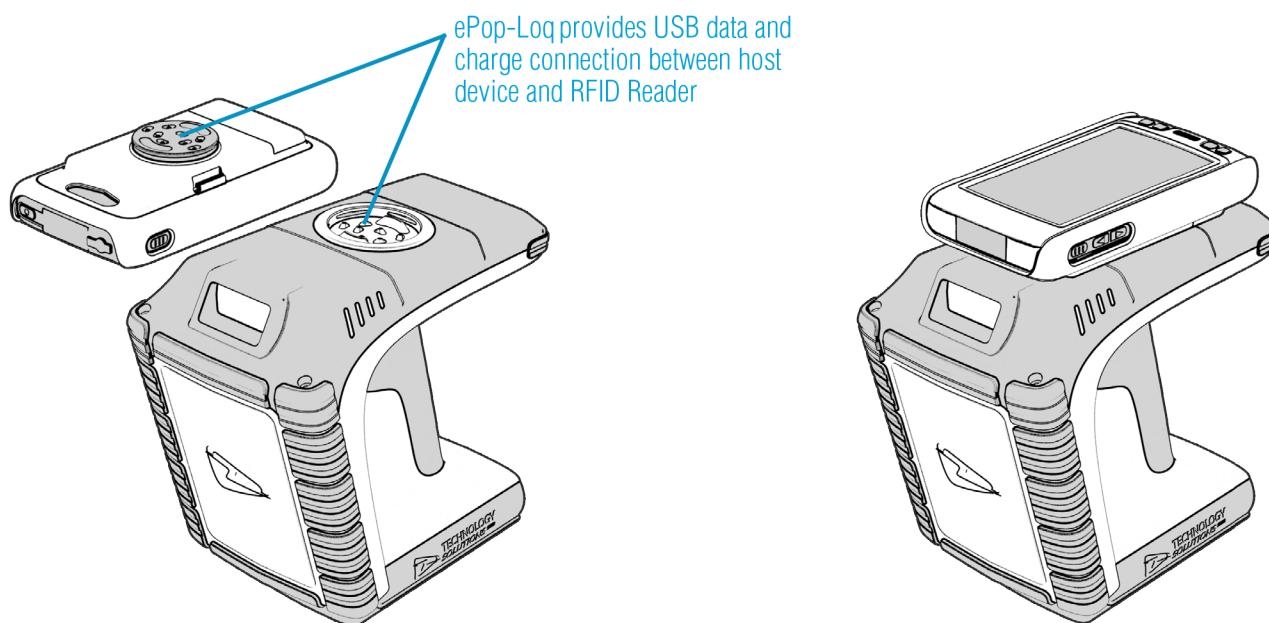

Figure 8: The ePop-Loq system

USB Operating Modes

Charge-and-Data mode:

The Memor 10 will use the USB data connection when not in the charging cradle. Note that USB data connection to the 3166 requires a custom application that supports *TSL ASCII2 Protocol Version 3* over USB.

N.B. The USB connector on the charging cradle is always available when the 3166 is docked.

BLUETOOTH WIRELESS TECHNOLOGY CONNECTION

Supported Apple iOS Devices

Made for

- iPhone 14 Pro Max
- iPhone 12
- iPhone 12 mini
- iPad (5th generation)

Other Compatible Products

The 3166 *Bluetooth* Rugged RAIN RFID UHF Reader is compatible with many other *Bluetooth* wireless technology enabled host devices running Android, iOS, Linux, Mac and Windows.

COMPARISON OF *BLUETOOTH* OPERATING MODES

Our UHF RFID *Bluetooth*® readers support two modes of operation over *Bluetooth*. When connected via USB the reader always supports *TSL ASCII2 Protocol Version 3* but when connected over *Bluetooth* the reader can either be set to use *TSL ASCII2 Protocol Version 3 (Bluetooth SPP Mode)* or it can appear as a *Bluetooth* keyboard (*Bluetooth HID Mode*).

The comparison chart below is designed to help you understand the differences between the two operating modes:

<i>Bluetooth</i> SPP Mode	<i>Bluetooth</i> HID Mode
Apps need to be written with specific support for the Reader	Apps can use the Reader without modification
<p>The Reader can be discovered and paired in the <i>Bluetooth</i> Settings or from within the App but the App controls the connection</p> <ul style="list-style-type: none"> ● Connects when instructed by the App ● Disconnects when instructed by the App ● The reader powers off when no longer connected and idle ● The App needs to connect to restore 	<p>Reader is discovered and paired in the Host <i>Bluetooth</i> Settings (often appears as a Keyboard)</p> <ul style="list-style-type: none"> ● After pairing the reader connects automatically ● If idle the reader sleeps and the connection is dropped ● The reader, when woken, automatically reconnects to the host device
Apps receive and interpret <i>ASCII2 Protocol Version 3</i> responses when the user triggers a UHF or barcode scan	Apps receive input as Key strokes from the reader including Tab and Return/Enter keys
<p>The App can respond and react intelligently to responses e.g.</p> <ul style="list-style-type: none"> ● duplicate responses can be ignored or counted ● incoming tag data can be truncated, stripped or transformed into alternative representations: Hex, ASCII, GS1 EPC URI, etc... 	<p>The reader types text for each barcode/UHF scan received</p> <ul style="list-style-type: none"> ● Tag values can be returned in Hex or ASCII representations ● Extra text may be included in the data returned ● The reader can trim tag/barcode data
The App can change the Reader's behaviour	The Reader can only send scanned data to the host, the host cannot change the reader's behaviour
The Reader's behaviour and command parameters are controlled in real time by the App e.g. the trigger action can change to suit the task that the User is performing; the App can allow the User to specify Inventory output power	The Reader's behaviour, such as the action of the reader's trigger switch, the inventory output power, the idle sleep timeout and other command parameters can be configured only once at start-up.
Configuration is held within the App (any configuration in the AUTO.TXT is likely to be overridden by the App settings)	All configuration is held in an AUTO.TXT file stored on an SD-Card. Removing the SD-card or deleting the AUTO.TXT and power-cycling the unit restores default settings.
All reader activity, by default, is saved to a log file if an SD-Card is fitted.	All reader activity, by default, is saved to a log file if an SD-card is fitted.

- Select **Action>Reset Bluetooth to SPP mode** (wait for the process to complete)
- Disconnect the UHF reader from the computer (unplug USB)
- Wake the UHF reader (pull trigger, blue flashing LED)
- Pair to the reader on the device
- Launch an Application (e.g. *RFID Explorer*) to use the reader

(*) if not download from here <http://www.ftdichip.com/Drivers/VCP.htm>

Further Information

Further information can be found from the Reader Download pages (free, one-time, registration required - see links above)

Application Note – Bluetooth HID mode: Provides further examples for configuring HID mode

Application Note – Using the Micro SD log and auto-run files: Describes using the AUTO.TXT

TSL ASCII Protocol 2.4 Rev B: Details all the commands including for HID `.st`, `.hs`, `.hc`, and `.hd`

If you encounter any issue while following the above procedure please contact support@tsl.com providing the following information:

- The serial number of the UHF Reader
- The Firmware version of the UHF Reader
- The step at which the procedure failed
- A description of the fault that occurred

SETTING UP A *BLUETOOTH* CONNECTION WITH AN APPLE PRODUCT

Awaken the 3166 UHF Reader by squeezing the trigger, which is confirmed by the flashing of the blue LED. To pair with your iOS device, navigate to the *Bluetooth* option within the Settings menu on your iOS device.

View list of *Bluetooth* Devices (iOS)

iPad® :

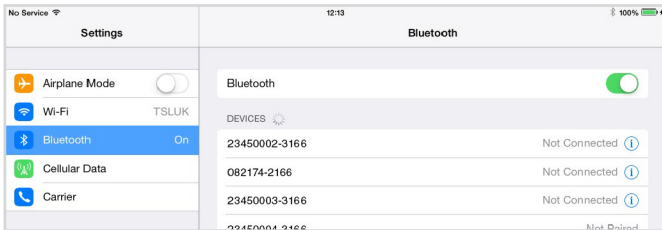

- Go to the Settings App.
- Select the *Bluetooth* settings in the left hand column.

Figure 9: List of devices in *Bluetooth* settings

iPhone® :

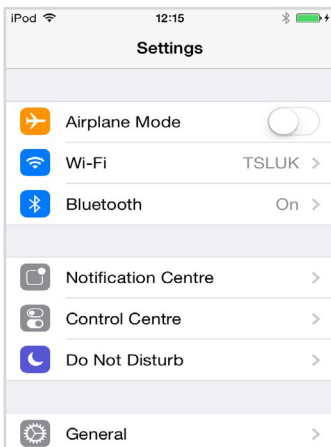

- Go to the Settings App.

Figure 10: Select *Bluetooth* settings



- Tap on the *Bluetooth* row to be taken to the *Bluetooth* settings

Figure 11: List of devices in *Bluetooth* settings

Pair with TSL Bluetooth Device

In the list of *Bluetooth* devices, the 3166 UHF reader will be identified by its serial number (3166-xxxxxx). Click on the corresponding row to pair with the reader.

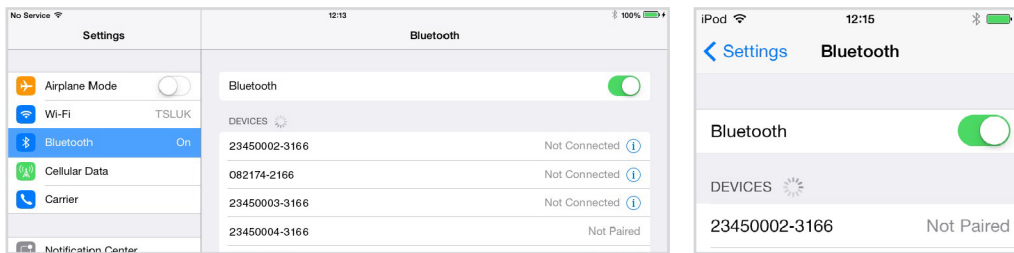

iPad®

iPhone®

Figure 12: Identify device

After successfully pairing with the 3166 UHF Reader, the device will be shown as 'connected'.

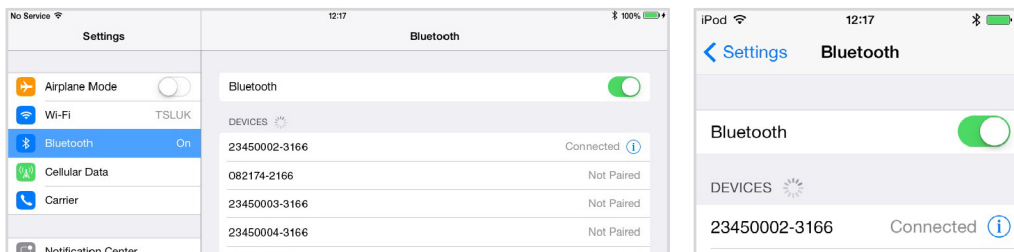

iPad®

iPhone®

Figure 13: Device connected

If RFID Explorer is installed on your device then a prompt will appear requesting a connection to the newly added reader. Choose 'Allow' to launch RFID Explorer or 'Ignore' if the device is to be used with a different App.

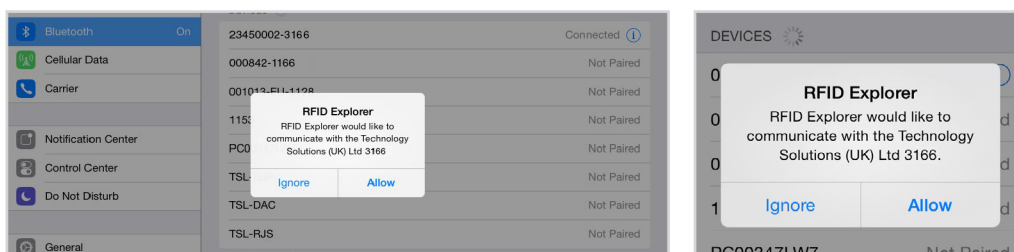

iPad®

iPhone®

Figure 14: Allow connection



Open TSL's RFID Explorer App.

The RFID Explorer App can be downloaded from the App Store.

If the app is starting up for the first time, no reader will be selected. To select a reader, tap on 'Change Reader' in the menu to the left (iPad®) or 'Paired Readers' (iPhone®).

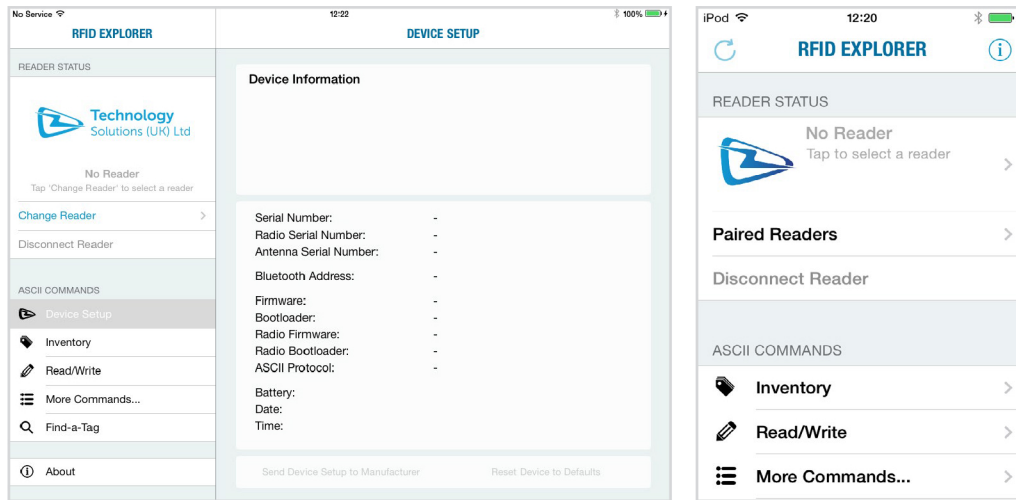

iPad®

iPhone®

Figure 15: TSL RFID Explorer App on first load - no reader selected

If you have a reader selected from your device's *Bluetooth* settings as previously shown, continue from Figure 28. If the 'No devices are available' message in Figure 25 appears, you can also connect to a device through the RFID Explorer app. Press the + sign presented in the top right corner of the Select Reader section/screen.

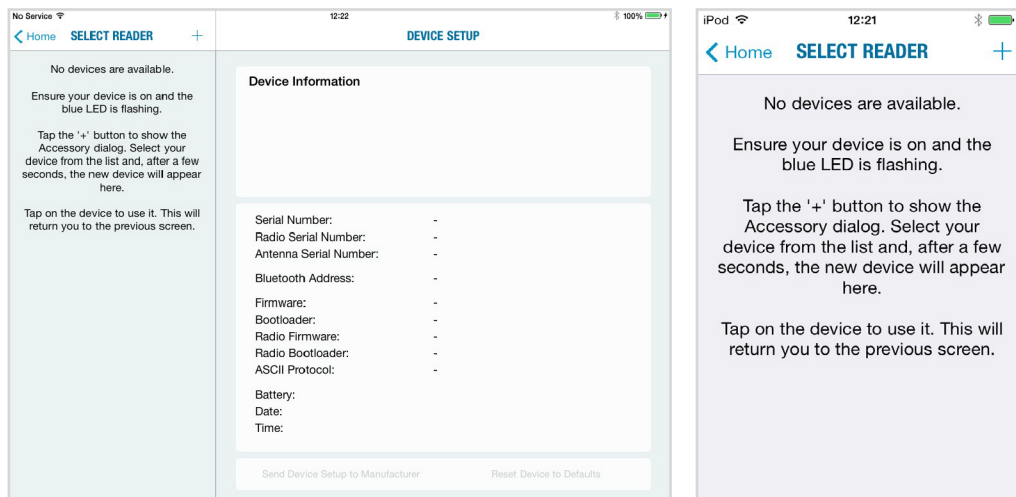

iPad®

iPhone®

Figure 16: No devices are available

BLUETOOTH WIRELESS TECHNOLOGY CONNECTION

This will open a 'Select An Accessory' dialog box.
There may be a small delay in loading available readers.

Once the available readers have loaded select the 3166 UHF reader.

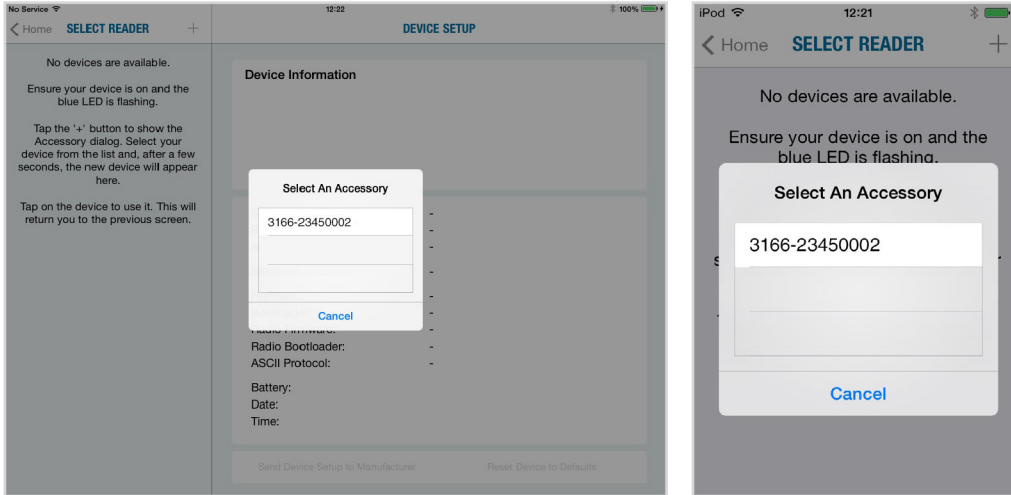

iPad®

iPhone®

Figure 17: Select the Reader to use

A list of compatible and currently paired *Bluetooth* devices will appear. Select the device to be used with the RFID Explorer App.

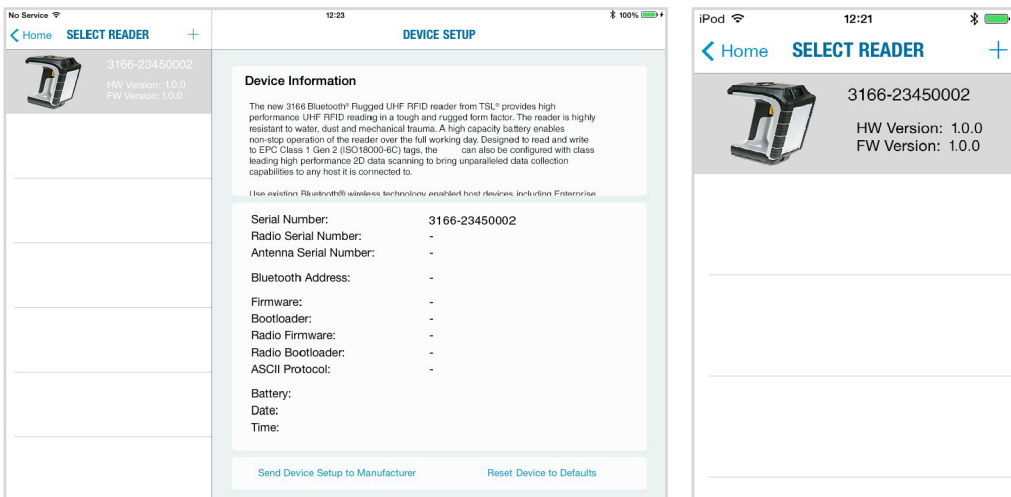

iPad®

iPhone®

Figure 18: List of paired *Bluetooth* devices

The selected device's image will appear, accompanied by relevant device information. The 'Inventory', 'Read/Write', 'Commands' and 'Find a Tag' features can now be explored. To maximise battery life it is recommended to release the 3166 UHF Reader from its *Bluetooth* connection if the reader is not to be used for a significant period of time.

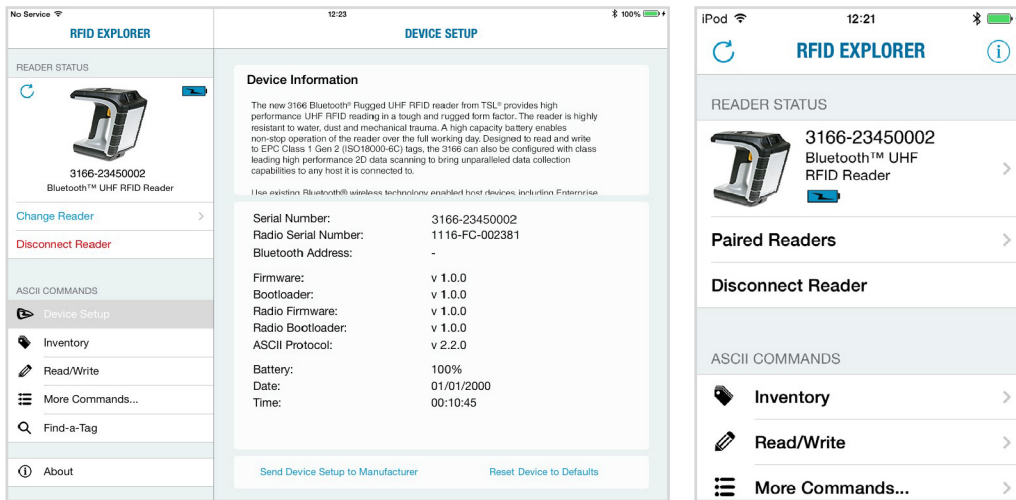

iPad®

iPhone®

Figure 19: 3166 UHF Reader selected and ready to use

EMBEDDED SD CARD

SUMMARY

The 3166 Bluetooth Rugged RAIN RFID UHF Reader is factory fitted with an embedded 32GB storage card, allowing millions of tags to be stored with time and date stamping.

Data written to the storage card can **only** be accessed via ASCII2 commands.

AUTORUN FILE (AUTO.TXT)

An Autorun file can be created on the embedded storage card. The Autorun file contains a list of ASCII2 commands that are executed as the 3166 powers up. The Autorun file is written/read/deleted by the `.ar` command

The file should be located at the root of the card and called "AUTO.TXT". Although the file can contain any valid ASCII2 commands, one per line, it is intended that these have the take no action '-n' flag specified to allow the default parameters for any command to be changed from the firmware defaults as the unit boots without actually executing the command.

For example to change the carrier power of the inventory command from 30dBm to 20dBm '`.iv -o20 -n`' would be appended to the Autorun file. As is the behaviour with command parameters this will set the output power for the inventory command until a new value is sent with this command. Therefore the inventories executed by the trigger, which executes '`.iv`' will use the modified output power.

The Autorun file can be manually created on the card before it is inserted into the 3166 or the ASCII2 command Write Command to Autorun File '`.wa`' can be used. The Read Autorun File '`.ra`' can be used to read back the contents of the Auto Run file or delete the file from the card.

LOG FILE (LOG.TXT)

If Logging is enabled, a log file is automatically created on the embedded storage card. The file is located at the root of the card and called "LOG.TXT". All the lines from every response to every command that is executed by the reader (including those performed from trigger actions) are appended to the end of the file. Events such as Power up are also appended to the file.

The ASCII2 Read Log File command ('`.rl`') is provided to enable or disable logging, to read the log file from the card or to delete the log file from the card.

Please note that the log file can quickly become large relative to the speed at which it can be downloaded using the Read Log File Command.

Start of a sample log output:

```
DT: 2023-09-15T16:46:58
EV: Log File created
CS: .ws -sa4 -sbepc -sd300833B2DDD9014000000000 -sl06 -so0002 -sts2 -dbepc -da330DE29525C0210005F5F88A
-dl06 -do0002
WW: 0
ME: No Transponder found
ER:005
DT: 2023-09-15T17:58:28
EV: Disconnected
DT: 2023-09-15T17:59:28
EV: Sleep
```

EMBEDDED SD CARD

```
DT: 2023-09-18T09:18:21
EV: Wake up
CS: .al -dlon
OK:
DT: 2023-09-18T09:19:22
EV: Sleep
DT: 2023-09-18T10:07:42
EV: Wake up
DT: 2023-09-18T10:07:42
EV: Connected USB
CS: .al -dlon
OK:
CS: .iv LCMD 000000 -qss0 -qta
EP: 330DE29525C0210005F5F8F2
EP: 22100150000000000000000027
OK:
```

SOFTWARE DEVELOPMENT

To make full use of the functionality of the 3166 UHF Reader, a customised software application will be required.

The new 3166 *Bluetooth* Rugged RAIN® RFID UHF Reader incorporates TSL's unique *ASCII2 Protocol Version 3* for faster and easier application development. This sophisticated parameterised protocol provides the developer a powerful set of commands that carry out multiple actions locally within the Bluetooth reader. This approach enables multiple tag operations executed using simple pre-configured ASCII commands which not only speeds integration of the reader into applications but also abstracts the developer from some of the complexities of the underlying Native API. Simple, text based commands are sent to the reader and responses are returned as text. This allows straightforward access to RFID tag functions such as inventory, read and write. Details of the ASCII command mode are available for download from <https://www.tsl.com/3166-downloads/>.

TROUBLESHOOTING AND MAINTENANCE

MAINTENANCE

For trouble-free service please observe the following tips when using the 3166 UHF Reader:

- Protect the 3166 UHF Reader from temperature extremes. Do not leave it on the dashboard of a car on a hot day, and keep it away from heat sources.

TROUBLESHOOTING

Symptoms	Possible cause	Action
Nothing happens when the trigger button is pressed.	If the LEDs are not on then the battery may be flat.	Charge the 3166 UHF Reader.
	The 3166 UHF Reader may have button actions disabled.	Check the 3166 UHF Reader configuration and restore to defaults if unsure.
	Other.	Work through Troubleshooting Guide on TSL Website
The orange LED flashes rapidly when charging.	There is a battery fault.	Replace the battery pack.
	The battery pack temperature is outside recommended limits.	Ensure that charging only occurs between 5°C and 40°C.
The host <i>Bluetooth</i> discovery does not find the 3166 UHF Reader.	The 3166 UHF Reader has powered off.	Press the trigger button and ensure the blue LED is flashing.
	The 3166 UHF Reader is out of range.	Move the 3166 UHF Reader closer to the host.
	The <i>Bluetooth</i> friendly name of the 3166 UHF Reader has been changed.	Check the <i>Bluetooth</i> friendly name or restore the 3166 UHF Reader to factory defaults if unsure.
Opening the <i>Bluetooth</i> virtual com port does not connect to the 3166 UHF Reader.	The host has paired to a different <i>Bluetooth</i> device.	Pair to the required 3166 UHF Reader.
	The host <i>Bluetooth</i> function has an error.	Warm boot the host. If this does not help, delete the 3166 UHF Reader from the favourites list and re-pair.
<i>Bluetooth</i> pairing fails.	The PIN on the 3166 UHF Reader has been changed	Set the <i>Bluetooth</i> PIN to a known value
Other symptoms.	Other fault.	Run ASCII Remote Diagnostic and email result to support@tsl.com along with a description of the problem.

REGULATORY INFORMATION

INFORMATION TO THE USER – FCC

Federal Communication Commission Interference Statement:

This device complies with Part 15 of the FCC Rules. Operation is subject to the following two conditions: (1) This device may not cause harmful interference, and (2) this device must accept any interference received, including interference that may cause undesired operation.

NOTE: This equipment has been tested and found to comply with the limits for a Class A digital device, pursuant to part 15 of the FCC Rules. These limits are designed to provide reasonable protection against harmful interference when the equipment is operated in a commercial environment. This equipment generates, uses, and can radiate radio frequency energy and, if not installed and used in accordance with the instruction manual, may cause harmful interference to radio communications. Operation of this equipment in a residential area is likely to cause harmful interference in which case the user will be required to correct the interference at his own expense.

FCC Caution:

- Any changes or modifications not expressly approved by the party responsible for compliance could void the user's authority to operate this equipment.
- This transmitter must not be co-located or operating in conjunction with any other antenna or transmitter.

Radiation Exposure Statement:

The product complies with the FCC portable RF exposure limit set forth for an uncontrolled environment and is safe for intended operation as described in this manual. Further RF exposure reduction can be achieved if the product is kept as far as possible from the user body or the device is set to a lower output power if such function is available.

CANADIAN WARNING STATEMENTS

Industry Canada Statement:

English

This device complies with ISED's licence-exempt RSSs. Operation is subject to the following two conditions: (1) This device may not cause harmful interference, and (2) this device must accept any interference received, including interference that may cause undesired operation.

Radiation Exposure Statement:

The product complies with the Canada portable RF exposure limit set forth for an uncontrolled environment and is safe for intended operation as described in this manual. Further RF exposure reduction can be achieved if the product can be kept as far as possible from the user body or by setting the device to use a lower output power if such a function is available.

French

Le présent appareil est conforme aux CNR d'ISED applicables aux appareils radio exempts de licence. L'exploitation est autorisée aux deux conditions suivantes : (1) le dispositif ne doit pas produire de brouillage préjudiciable, et (2) ce dispositif doit accepter tout brouillage reçu, y compris un brouillage susceptible de provoquer un fonctionnement indésirable.

Déclaration d'exposition aux radiations:

Le produit est conforme aux limites d'exposition pour les appareils portables RF pour les Etats-Unis et le Canada établies pour un environnement non contrôlé.

Le produit est sûr pour un fonctionnement tel que décrit dans ce manuel. La réduction aux expositions RF peut être augmentée si l'appareil peut être conservé aussi loin que possible du corps de l'utilisateur ou que le dispositif est réglé sur la puissance de sortie la plus faible si une telle fonction est disponible.

BATTERY INFORMATION



CAUTION

RISK OF EXPLOSION IF BATTERY IS REPLACED BY AN INCORRECT TYPE.

DISPOSE OF USED BATTERIES ACCORDING TO THE INSTRUCTIONS.

- CHARGING TEMPERATURE: 5°C TO 40°C (41°F TO 104°F)
- If the battery is replaced by an incorrect type, this could result in an explosion.
- Dispose of batteries according to instructions.
- Use only TSL-approved batteries.
- Use only TSL-approved chargers.
- There are limits on how long a battery can operate or be in storage before replacement is required. The life cycle of a battery can be affected by factors such as heat, cold, harsh environments and impacts or drops.

HEALTH AND SAFETY RECOMMENDATIONS

Ergonomic Recommendations

Caution: In order to avoid or minimize the potential risk of ergonomic injury, follow the recommendations below. Consult with your local Health & Safety Manager to ensure that you are adhering to your company's safety programs to prevent employee injury.

- Reduce or eliminate repetitive motion
- Maintain a natural position
- Reduce or eliminate excessive force
- Keep objects that are used frequently within easy reach Perform tasks at correct heights
- Reduce or eliminate vibration
- Reduce or eliminate direct pressure
- Provide adjustable workstations
- Provide adequate clearance
- Provide a suitable working environment
- Improve work procedures.

For vehicle installation and use

An air bag inflates with great force. DO NOT place objects, including either installed or portable wireless equipment, in the area over the air bag or in the air bag deployment area. If in-vehicle wireless equipment is improperly installed and the air bag inflates, serious injury could result.

RF signals may affect improperly installed or inadequately shielded electronic systems in motor vehicles (including safety systems). Check with the manufacturer or its representative regarding your vehicle. You should also consult the manufacturer of any equipment that has been added to your vehicle.

Power Supply

Use only TSL-approved cradles, chargers and power supplies with the 3166 UHF Reader. Use of an alternative power supply will invalidate any approval given to this device, void the warranty for the product and may be dangerous.

WASTE ELECTRICAL AND ELECTRONIC EQUIPMENT (WEEE)

For EU Customers: All products at the end of their life must be returned to TSL for recycling. For information on how to return product please contact TSL.

WARRANTY

(A) Warranty

TSL's hardware Products are warranted against defects in workmanship and materials for a period of twelve (12) months from the date of shipment, unless otherwise provided by TSL in writing, provided the Product remains unmodified and is operated under normal and proper conditions. Warranty provisions and durations on software, integrated installed systems, Product modified or designed to meet specific customer specifications ("Custom Products"), remanufactured products, and reconditioned or upgraded products, shall be as provided in the applicable Product specification in effect at the time of purchase or in the accompanying software license.

(B) Spare Parts

Spare parts (i.e. parts, components, or subassemblies sold by TSL for use in the service and maintenance of Products) are warranted against defects in workmanship and materials for a period of thirty (30) days from the date of shipment. Spare parts may be new or originate from returned units under the conditions set forth in subsection D below.

(C) Repair of TSL branded hardware

For repairs on TSL branded hardware Products under this Agreement, including repairs covered by warranty, the repair services provided are warranted against defects in workmanship and materials on the repaired component of the Product for a period of thirty (30) days from the shipment date of the repaired Product, or until the end of the original warranty period, whichever is longer. Any such defects shall be notified to TSL in writing within 7 days of the same becoming apparent.

(D) Product Service

Products may be serviced or manufactured with parts, components, or subassemblies that originate from returned products and that have been tested as meeting applicable specifications for equivalent new material and Products. The sole obligation of TSL for defective hardware Products is limited to repair or replacement (at TSL's option) on a "return to base (RTB)" basis with prior TSL authorisation.

Customer is responsible for prompt shipment to TSL and assumes all costs and risks associated with this transportation; return shipment to the Customer will be at TSL's expense. Customer shall be responsible for return shipment charges for product returned where TSL determines there is no defect ("No Defect Found"), or for product returned that TSL determines is not eligible for warranty repair. No charge will be made to Buyer for replacement parts for warranty repairs. TSL is not responsible for any damage to or loss of any software programs, data or removable data storage media, or the restoration or reinstallation of any software programs or data other than the software, if any, installed by TSL during manufacture of the Product.

(E) Original Warranty Period

Except for the warranty applying solely to the repaired component arising from a repair service as provided in Section C above, the aforementioned provisions do not extend the original warranty period of any Product that had either been repaired or replaced by TSL.

(F) Warranty Provisions

The above warranty provisions shall not apply to any Product:

- (i) which has been repaired, tampered with, altered or modified, except by TSL's authorized service personnel;
- (ii) in which the defects or damage to the Product result from normal wear and tear, misuse, negligence, improper storage, water or other liquids, battery leakage, use of parts or accessories not approved or supplied by TSL, or failure to perform operator handling and scheduled maintenance instructions supplied by TSL;
- (iii) which has been subjected to unusual physical or electrical stress, abuse, or accident, or forces or exposure beyond normal use within the specified operational and environmental parameters set forth in the applicable Product specification; nor shall the above warranty provisions apply to any expendable or consumable items, such as batteries, supplied with the Product.

EXCEPT FOR THE WARRANTY OF TITLE AND THE EXPRESS WARRANTIES STATED ABOVE, TSL DISCLAIMS ALL WARRANTIES ON PRODUCTS FURNISHED HEREUNDER INCLUDING ALL IMPLIED WARRANTIES OF MERCHANTABILITY AND FITNESS FOR A PARTICULAR USE. ANY IMPLIED WARRANTIES THAT MAY BE IMPOSED BY LAW ARE LIMITED IN DURATION TO THE LIMITED WARRANTY PERIOD. SOME STATES OR COUNTRIES DO NOT ALLOW A LIMITATION ON HOW LONG AN IMPLIED WARRANTY LASTS OR THE EXCLUSION OR LIMITATION OF INCIDENTAL OR CONSEQUENTIAL DAMAGES OR CONSUMER PRODUCTS. IN SUCH STATES OR COUNTRIES, FOR SUCH PRODUCTS, SOME EXCLUSIONS OR LIMITATIONS OF THIS LIMITED WARRANTY MAY NOT APPLY.

The stated express warranties are in lieu of all obligations or liabilities on the part of TSL for damages, including but not limited to, special, indirect or consequential damages arising out of or in connection with the use or performance of the Product or service. TSL's liability for damages to Buyer or others resulting from the use of any Product or service furnished hereunder shall in no way exceed the purchase price of said Product or the fair market value of said service, except in instances of injury to persons or property.

TSL is not responsible for any damages incurred during shipment if the approved shipping container is not used. Shipping the units improperly can possibly void the warranty. If the original shipping container was not kept, contact your local distributor or TSL to have another sent to you.

TSL shall not be responsible for any injury, damage or loss of whatever kind caused directly or indirectly by the goods whether as a result of their manufacture, operation, use or otherwise and the customer shall indemnify TSL from any claim arising from any loss suffered by any third party.

ABOUT

ABOUT TSL



Technology Solutions UK Ltd (TSL), part of HID, is a leading manufacturer of high performance mobile RFID readers used to identify and track products, assets, data or personnel.

For over two decades, TSL has delivered innovative data capture solutions to Fortune 500 companies around the world using a global network of distributors and system integrators. Specialist in-house teams design all aspects of the finished products and software ecosystems, including electronics, firmware, application development tools, RF design and injection mould tooling.

TSL is an ISO 9001:2015 certified company.



ISO 9001: 2015

ABOUT HID



HID powers the trusted identities of the world's people, places and things. We make it possible for people to transact safely, work productively and travel freely. Our trusted identity solutions give **people** convenient access to physical and digital **places** and connect **things** that can be identified, verified and tracked digitally. Millions of people around the world use HID products and services to navigate their everyday lives, and billions of things are connected through HID technology. We work with governments, educational institutions, hospitals, financial institutions, industrial businesses and some of the most innovative companies on the planet. Headquartered in Austin, Texas, HID has over 4,000 employees worldwide and operates international offices that support more than 100 countries. HID is an ASSA ABLOY Group brand.

For more information, visit www.hidglobal.com.



Technology Solutions (UK) Ltd reserves the right to change its products, specifications and services at any time without notice.